



Installation Guidelines for Multi-Slide M2055 Pocket Door with Weather Resistant Barrier Installed

PO Box 128

| 504 Highway 63 South

| Freeburg, MO 65035

| 800-347-0438

Read these instructions completely before starting any installation. Failure to install and maintain our product according to these instructions may void any product warranty. These are generic instructions intended to cover most common situations, which may not be appropriate for all installations due to building design, construction materials, or methods used and/or building or site conditions. Please visit our website at www.quakerwindows.com or call 1-800-347-0438 for additional information. Inspect all units for any damage or defects prior to installation.

Tools required by installer:

Safety Glasses		Utility Knife	
Drill/Driver		Caulk Gun	
Level		Tape Measure	
Hammer		J-Roller	
Putty Knife		Staple Gun	
Phillips #2 Screwdriver		Metal Cutting Saw	
Torx #20 Bits			

Materials required by installer:

Foam Backer Rod		Minimally Expanding Spray Foam	
Shims (waterproof)		C920 Silicone	
Flashing Tape (Self-Ahering)		Water Resistant Barrier/House Wrap (WRB)	
Fasteners		IPA Alcohol	
		Drip Cap	
		Panning Tank	

⚠ WARNING

Tools

- Follow manufacturer's instructions for safe operation of tools, and ladders/scaffolding. Always wear safety glasses. Failure to do so could result in injury, product or property damage.

Handling

- Do not store units outside, or in a hot environment. Doing so could result in product damage.
- Do not carry flat.** Doing so could result in product damage, injury, or property damage.
- Stack units as straight as possible to avoid bowing. **Do not lay flat!**

Glass

- If broken, glass can fragment causing injury. All Quaker products are available with safety glass. In many areas, local building codes require safety glass in certain locations and/or applications. Quaker door products are provided with safety glass per industry standards. Consult your local building codes for more definitive information.

Fastening

- Metal fasteners and components could corrode when used with preservative-treated lumber. Use approved fasteners and components to fasten window or door. Failure to do so could cause a failure resulting in injury, product or property damage.
- Fastener must attach to a structural framing member with 1 1/2" minimum fastener embedment, or minimum 3 full threads with a minimum 5/16" head as products were tested with.
- Quaker does not supply anchorage/fastener calculations, and is not responsible for determining structural adequacy of the anchorage and fasteners used to install our products, or the openings into which they are installed.**
- Do not over drive screws or nails.** Doing so could result in product damage.

Notice

- The suggested overhang of the structure should match the height of the unit being installed.

CAUTION**Installation**

- Maintain a minimum of 1/4" between the window or door frame and exterior finish materials. Failure to do so could result in product or property damage.
- Nailing flanges and drip caps (integral or applied) **do not** take the place of window and door flashing. All windows and doors must be properly flashed and sealed with material compatible sealant for protection against water and air infiltration around the entire perimeter. Failure to do so could result in product or property damage.
- Place shims around perimeter as required. Door must be properly shimmed. Failure to do so could affect operation and product performance and could result in product damage.
- Live or dead loads transferred into our product can affect functionality, damage frame joinery or cause glass failures. Dead loads such as upper levels, roof, etc. Should be constructed before window or door is installed.
- Loads shall be designed to withstand the most critical effects of load factors and load combinations as required by the building code. (Loads are including but not limited to Live, Dead, Collateral, Auxiliary, Thermally induced, Seismic, etc.)
- Maximum vertical deflection of the header under all Load combination should not exceed 1/8".
- **Do not** drill through or into door sill to install alarm wires.

Sealing

- Follow instructions of foam, sealant, and flashing manufacturers regarding safety, material application, compatibility, and periodic maintenance for continued weather resistance of their products. Failure to do so could result in product or property damage. **DO NOT** overfill between the frame and opening.
- Minimally expanding foam insulation must be compliant with AAMA 812-19.
- Quaker requires 100% silicone (ASTM C920 compliant) neutral cure only sealant. Always clean all areas where sealant will be applied. Failure to do so could result in product or property damage.
- Flashing tape must meet ASTM-D779 performance requirements.

Joining

- Do not join any window or door to any window or door not designed for joining. Joined windows and doors must be individually supported in the opening. Failure to do so could affect operation and product performance and could result in product or property damage.

Cleaning

- Acid solutions used for cleaning will damage glass, fasteners, hardware, and metal flashing. Protect these products and follow cleaning products manufacturers instructions. If acid contacts the window or door, wash all surfaces immediately with clean water.
- **Do not** use razor blades to clean glass surface. Glass damage could result.
- Clean glass using liquid glass cleaner.
- Clean frame, sash, panels, and insect screens using mild detergent and warm water with a soft cloth or brush.

IMPORTANT

- Buildings constructed prior to 1978 could contain lead paint which could be disturbed during window or door replacement. For more information on proper management of lead paint, go to: www.epa.gov/lead
- Care must be taken to properly recycle or dispose of old materials. Any recyclable materials should be separated from non-recyclable or hazardous materials. Please consult with local or state authorities regarding proper disposal of non-recyclable or hazardous materials

! **WARNING:** This product can expose you to chemicals including titanium dioxide or methanol, which are known to the State of California to cause cancer and birth defects or other reproductive harm. For more information go to www.P65Warnings.ca.gov.

! **WARNING:** Drilling, sawing, sanding or machining wood products can expose you to wood dust, a substance known to the State of California to cause cancer. Avoid inhaling wood dust or use a dust mask or other safeguards for personal protection. For more information go to www.P65Warnings.ca.gov/wood.

1 Verify Header Support

Ensure the roof over the door system is full supported. Take into account the weight of any materials around the door system, because this may cause deflection. No more than 1/8" deflection is allowed for install. Confirm that all materials and fasteners are adequate for the load requirements.

If you have any questions please feel free to call us at Quaker Windows.
Phone : 1 (800) 347 – 0438.

2

Check and verify that the shop drawings are accurate to the opening.

3

Exterior Wall

DO NOT build the interior wall until after the frame and panels are installed.

4

Prior to starting, line inside of the exterior wall with black board.

5

Before installing your door, unpack all parts and place near the opening. Make sure you have all parts according to the packing slip and check for damaged parts.

6

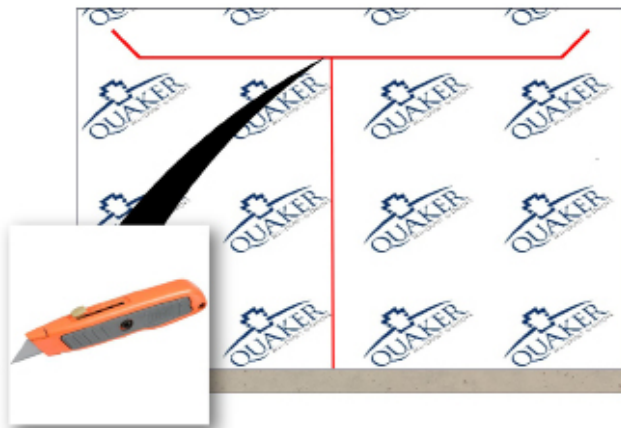

Apply the house wrap according to the manufacturer's instructions and cut T-pattern opening as shown above. Cut top flap angles at 45 degrees and 1" longer than the width of flashing tape being used.

7

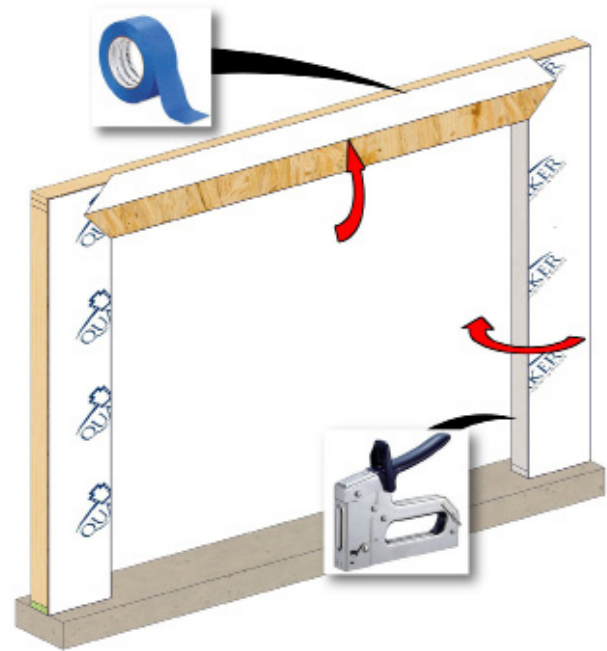

Fold the house wrap around the jambs to the interior and staple it to the interior framing. Fold the house wrap flap up and temporarily tape it in place.

8

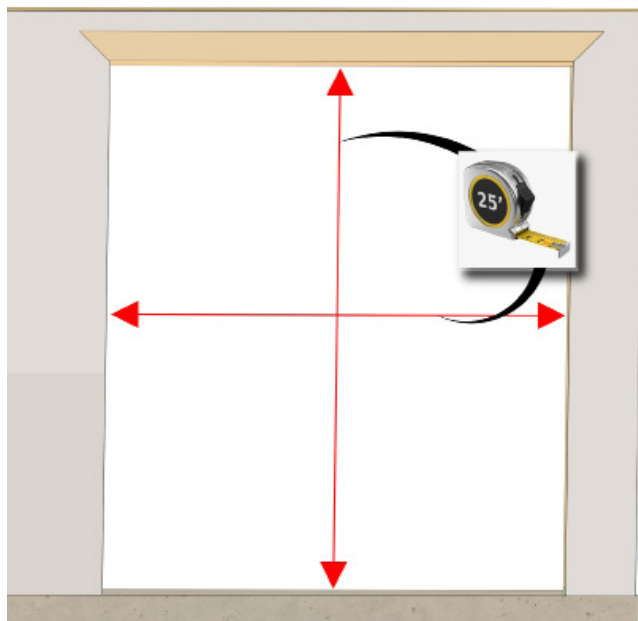

Measure and verify the rough opening is sized correctly. The frame opening should be $13/16$ " wider and $1/2$ " taller than the framed unit. Allow additional space for flashing thickness, installation clips, joining components, and their fasteners.

9

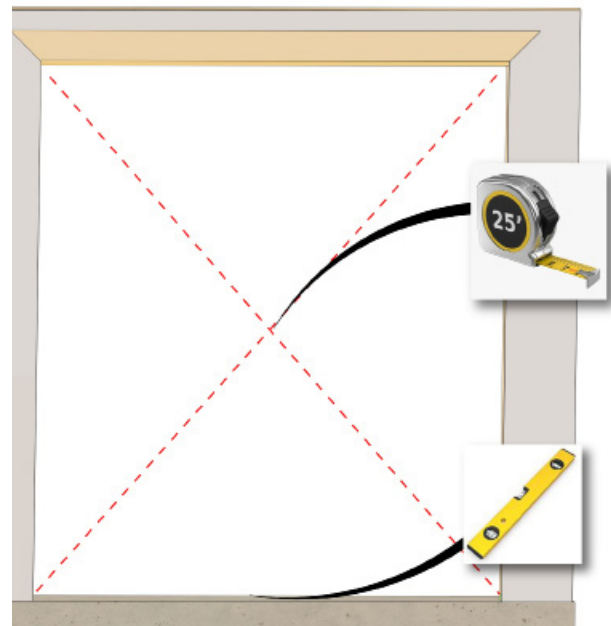

Check that the opening is square. The diagonal measurements need to be within $1/8$ " of each other. Verify the rough opening is plumb and level.



The sill plate beneath the unit must be level for proper unit operation.

10



Measure 1/2" toward the inside and snap a chalk line where the sill pan will sit.

The sill condition must be level.

11

Pocket Sizing Chart	
Number of panels	Black board to Black board
2	7.25
3	7.25
4	9.1875
5	11.125
6	13.0625
7	15
8	16.9375
9	18.875
10	20.8125
11	22.75
12	24.6875

See the chart above for pocket depth from black board to black board.

12

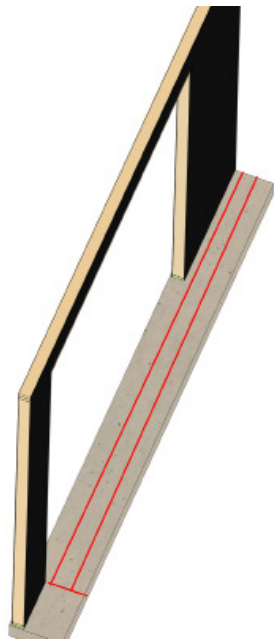

Snap another chalk line, width of sill pan from previous chalk line. This is where the flashing pan will sit.

13

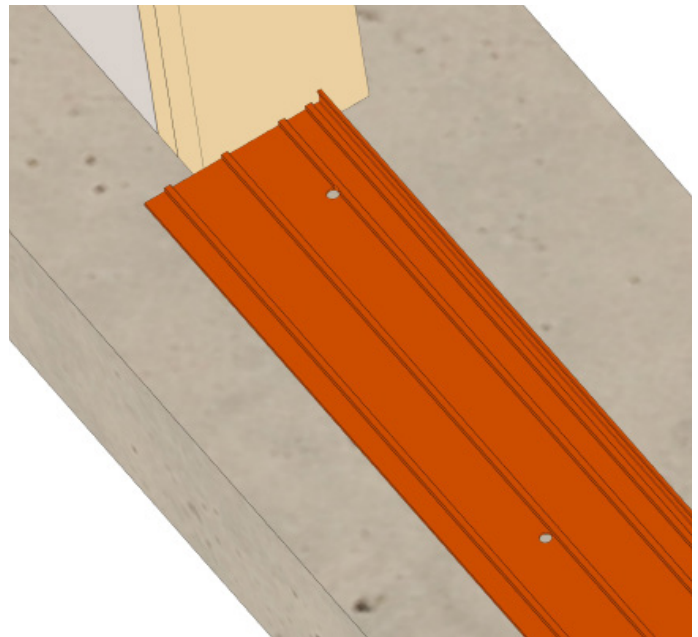

Rough fit the sill pan in place to ensure of proper fitment.

SILL MUST BE LEVEL! Quaker first recommends **self leveling concrete**, if not available shim 1' or less, on center.

FRAME ASSEMBLY

Assemble the frame to make sure sizing is correct.

If you have a double pocket door assemble the head and sill.

Multi Tracks - See below - Skip to the step that matches the door which you are wanting to install.

14

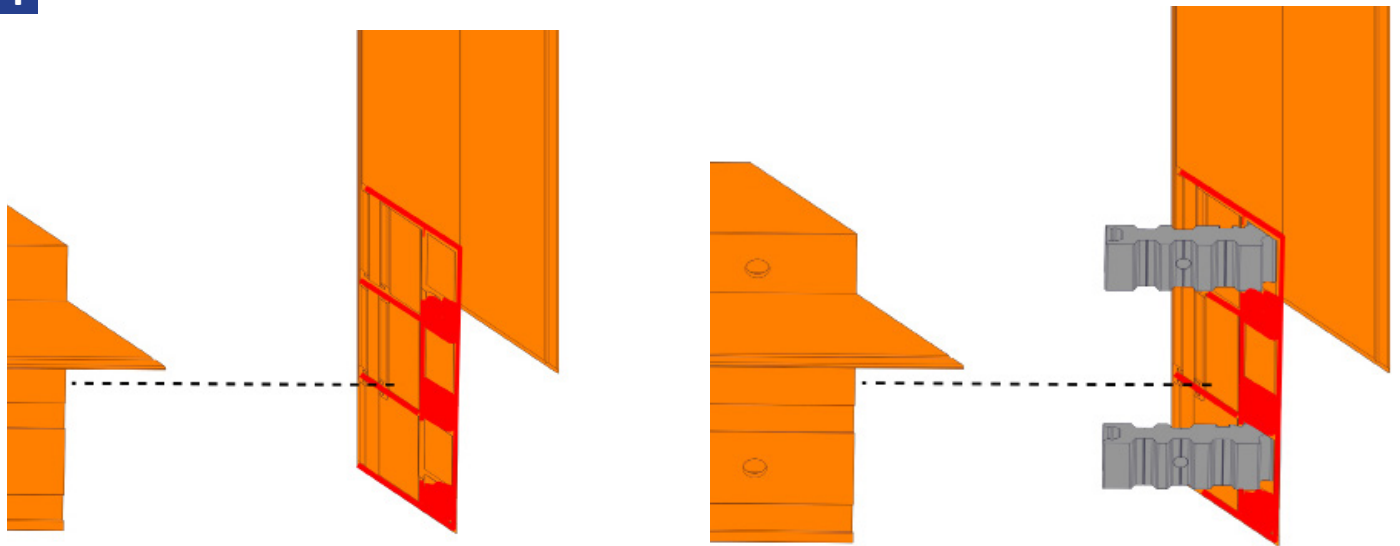

Place a gasket (Part #: QWP-MMSD-V4FG1(B/W)) on each face profile of the frame header. Place 2 of the corner keys (Part #: FE_25-7x10-35-DT) in both ends of the frame header and join to both frame jambs. Trim weather strip flush to both ends.

NOTE: One end of the head will be mitered, and one will be straight cut.

14

4 Tracks

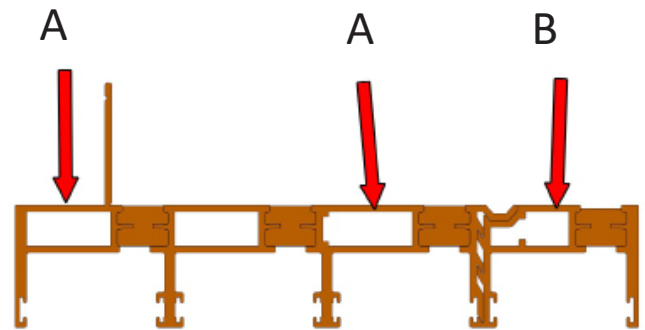
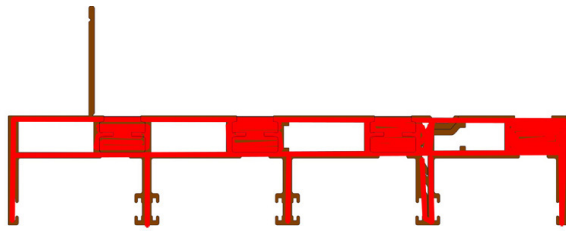

Place a gasket (Part #: QWP-MMSD-V5FG4(B/W)) on each face profile of the frame header. Place 2 of the corner keys (Part #: FE_25-7x10-35-DT) in both ends of the frame header by arrow (A) and place corner key (Part #: M25762-PCS) by arrow (B). Then join to both frame jambs to head. Trim weather strip flush to both ends.

14

5 Tracks

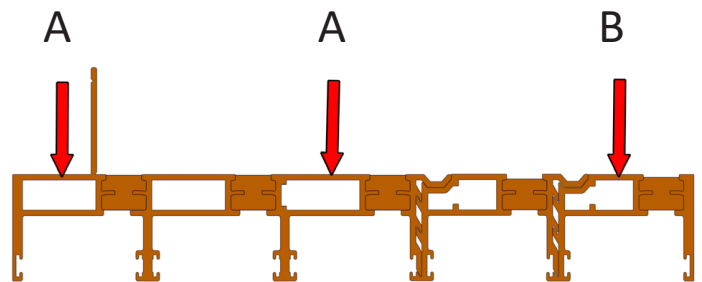
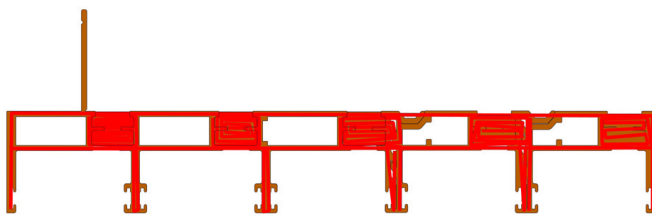

Place a gasket (Part #: QWP-MMSD-V5FG5(B/W)) on each face profile of the frame header. Place 2 of the corner keys (Part #: FE_25-7x10-35-DT) in both ends of the frame header by arrow (A) and place corner key (Part #: M25762-PCS) by arrow (B). Then join to both frame jambs to head. Trim weather strip flush to both ends.

14

6 Tracks

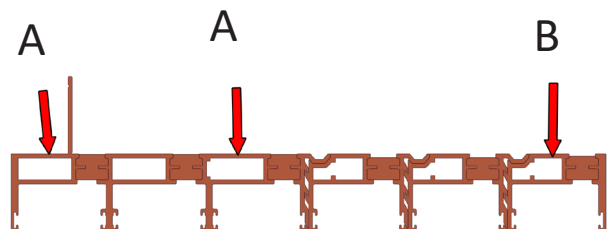
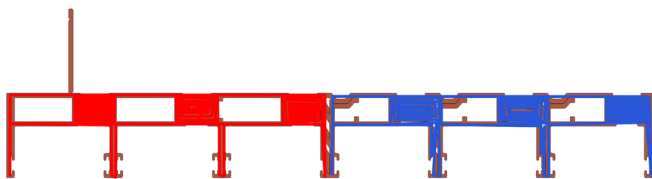

Place gasket (Part #: QWP-MMSD-V4FG1(B/W)) (RED) on the first three tracks, and then place gasket (Part #: QWP-MMSD-V5FG6(B/W)) (BLUE) on the other three tracks. This will go on each face profile of the frame header. Place 2 of the corner keys (Part #: FE_25-7x10-35-DT) in both ends of the frame header by arrow (A) and place corner key (Part #: M25762-PCS) by arrow (B). Then join to both frame jambs to head. Trim weather strip flush to both ends.

15

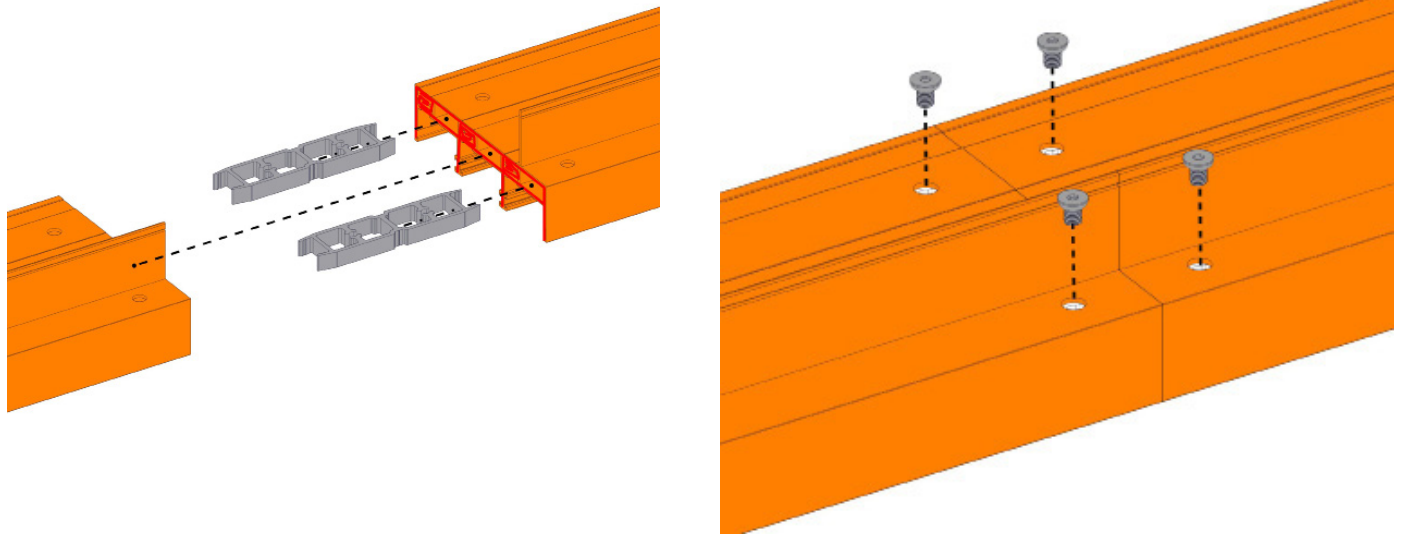

For Two-piece Headers Needing a Splice:

Place a gasket on the face profile of the frame header. Put two splice keys in the first header as shown & screw those in place with 2 corner key screws. Then slide the other header over the keys and secure in place with 2 more corner key screws.

3 Tracks

Gaskets -
QWP-MMSD-V4FG2(B/W)
Corner keys-
FE_26X10_200_TC

4 Tracks

Gaskets -
QWP-MMSD-V5FG7(B/W)
Corner Keys -
FE_26X10_200_TC and M25762-PCS

5 Tracks

Gaskets -
QWP-MMSD-V5FG8(B/W)
Corner Keys -
FE_26X10_200_TC and M25762-PCS

6 Tracks

Gaskets -
QWP-MMSD-V4FG2(B/W) and QWP-MMSD-V5FG9(B/W)
Corner Keys -
FE_26X10_200_TC and M25762-PCS

16

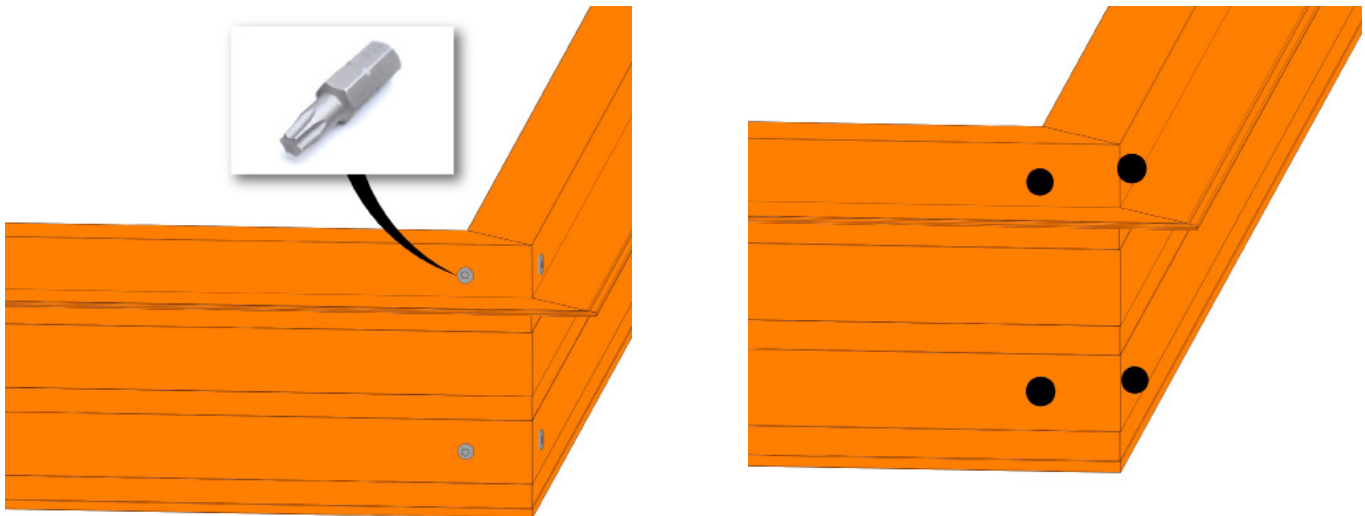

Start screws (Part #: FE FAST2) into the keys at each corner.
Then tighten.
Cover screws with silicone.

17

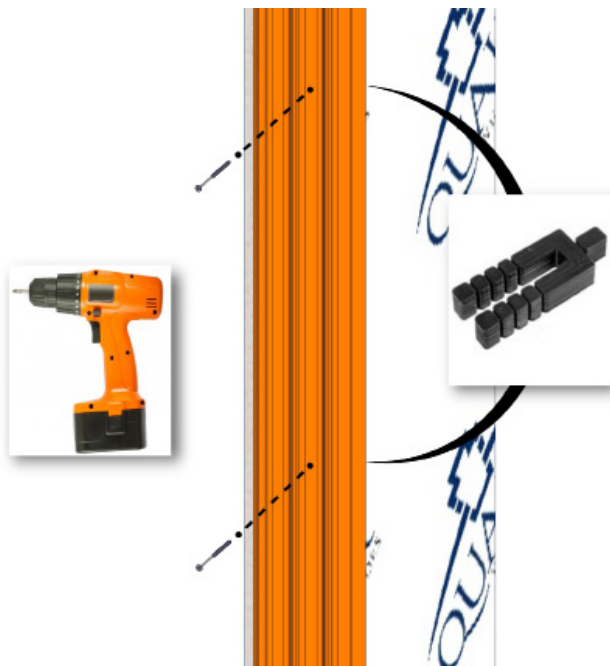

Drill holes through the center track of the header & jambs,
typically 6" from ends and 24" on center.
(Drill bit size is based off the screw being used.)

SILL PAN INSTALL

For the different track configurations the sills and sill pan will install the exact same way, the only difference between them will be the widths of them both.

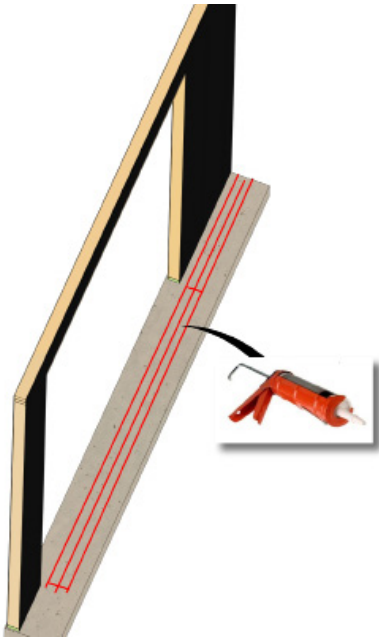
18

Apply three 3/8" continuous beads of sealant across the entire width of the rough opening sill where the flashing pan will set. Apply two 3/8" continuous beads of sealant the width of the pan, 1/2" from each side of opening as shown above.

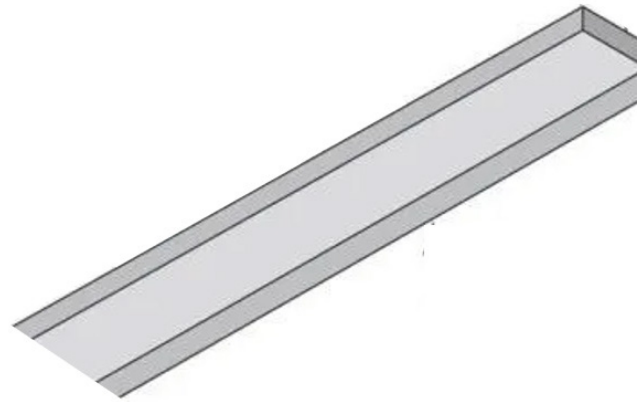
19

Install the tank (supplied by others), in the pocket and water proof the tank according to AAMA or ASTM standards.

20

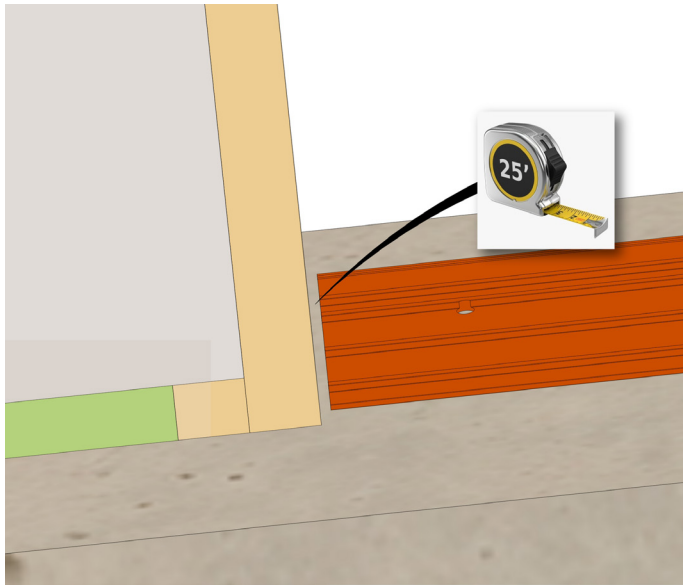

Allow a 1/4" gap between the rough opening and the sill pan. This should also include a 1/4" from the back of the tank.

21

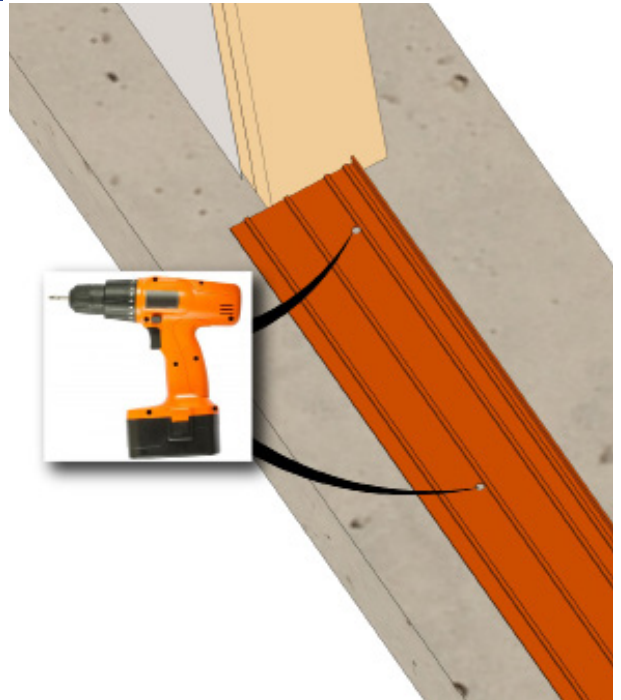

Locate second and third leg and drill holes directly behind them. Drill holes through the sill pan, 3" from each end and then 14" on center for the length of the pan, alternating between the 2 tracks.
(Drill bit size is based off screw size)

22

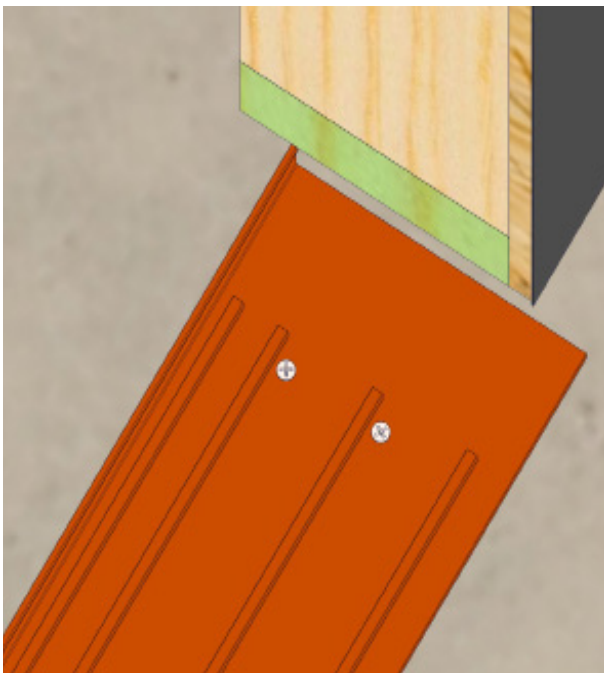

Using a screw with the head is shorter (less than .150"), screw down the sill pan.

23

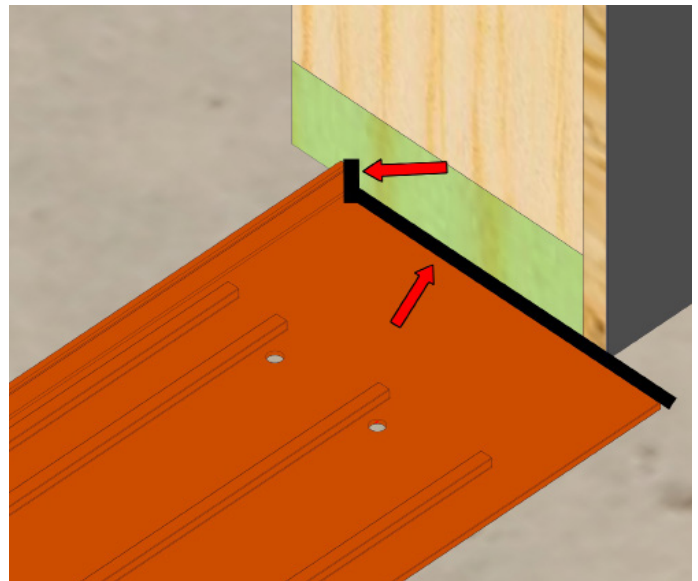

Set the sill pan in place along the wall and upturned leg apply silicone. Be sure to tool in the sealant.

24

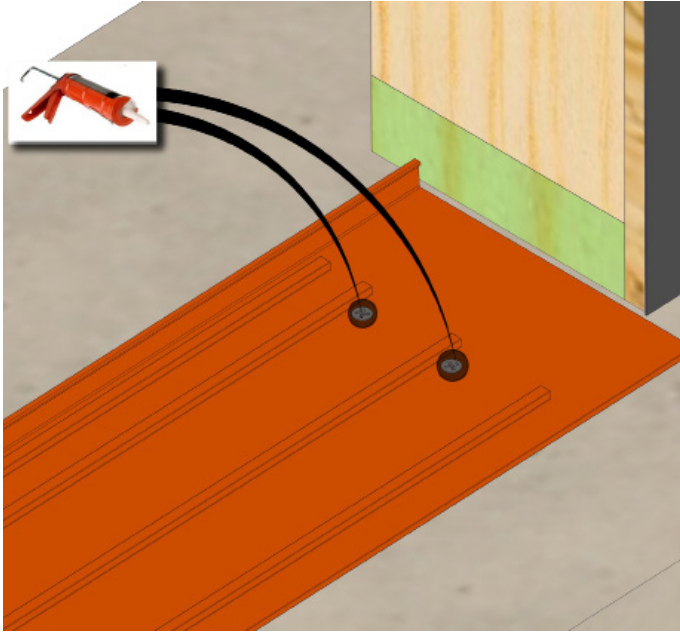

Silicone over all screws and tool in.

FRAME INSTALL

If you have a double pocket door make sure the head and sill are lined up.

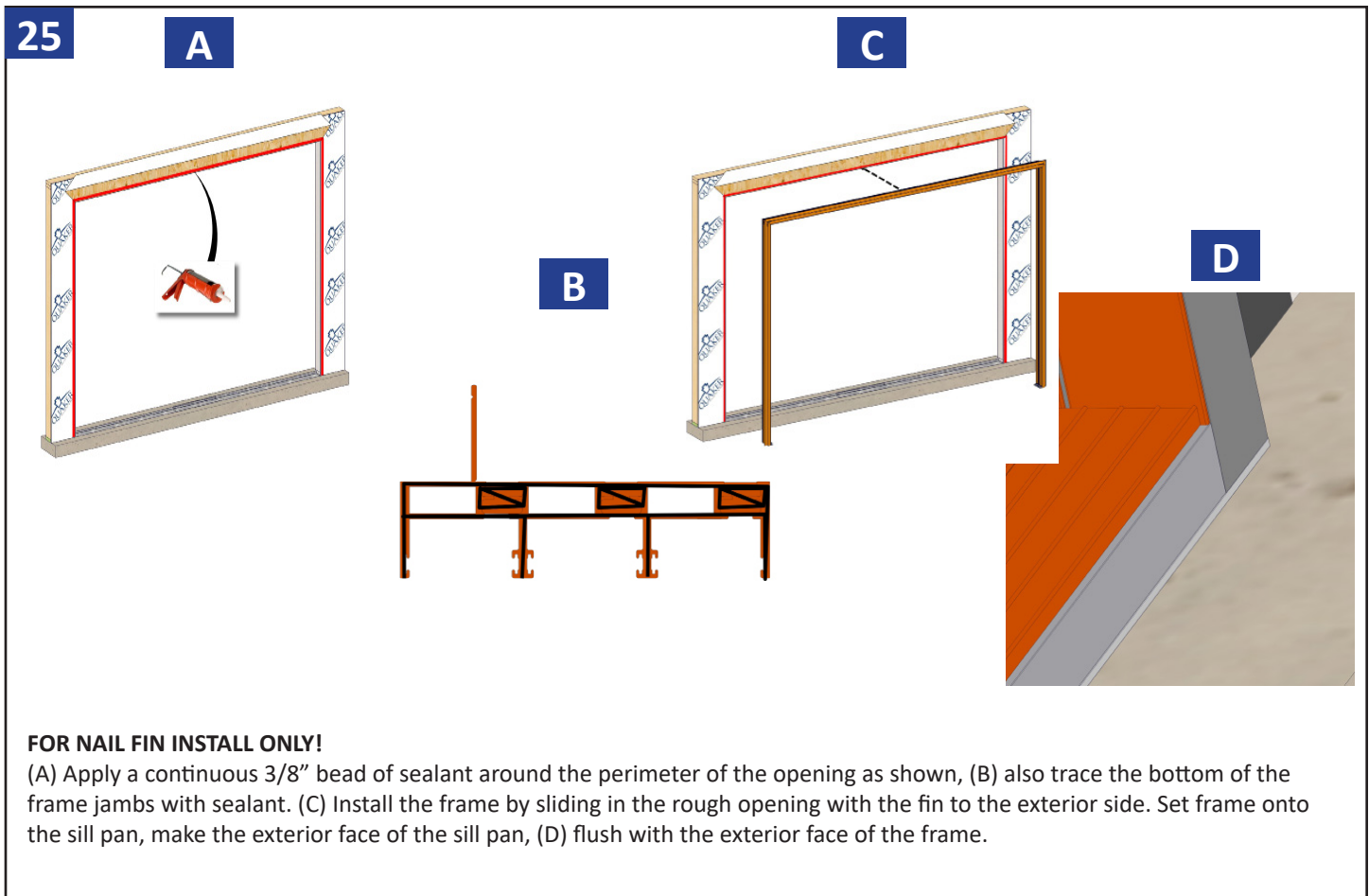

26

A



B

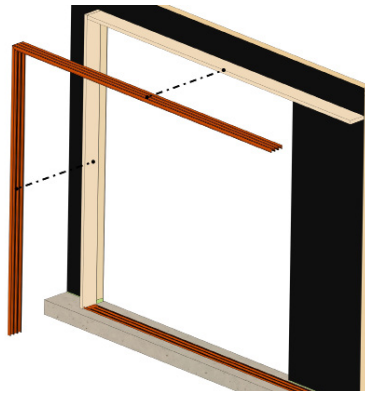

C

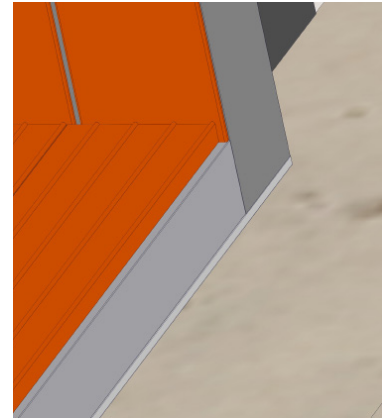
**FOR NO NAIL FIN INSTALL ONLY!**

(A) Trace the bottom of the frame jambs with sealant. (B) From the interior, install the frame by sliding in the rough opening. (C) Set frame onto the sill pan, make the exterior face of the sill pan, flush with the exterior face of the frame.

27

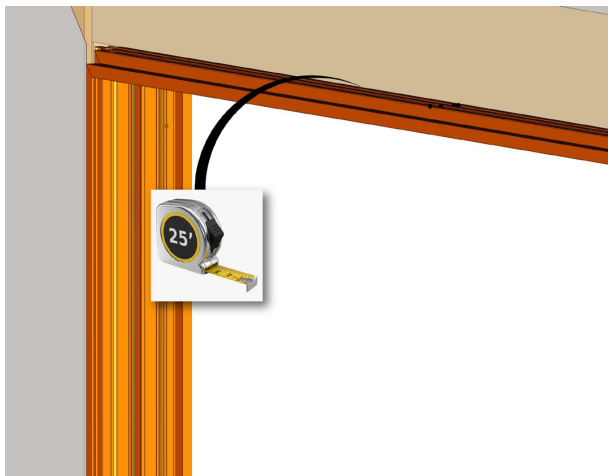

Set frame in place and measure off the exterior wall to keep it in line with the opening.

28

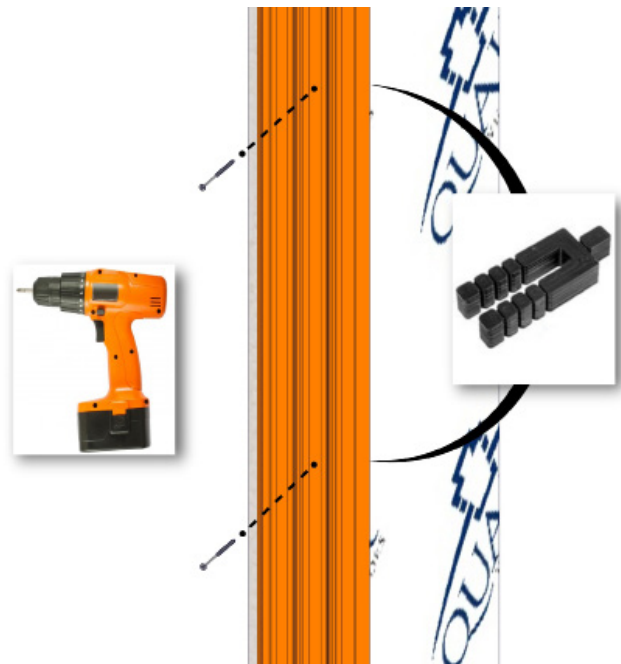

Temporarily set screw just deep enough to hold the frame in place. The screws through the center track of the header & jambs, typically 6" from ends and 24" on center for fasteners.

29

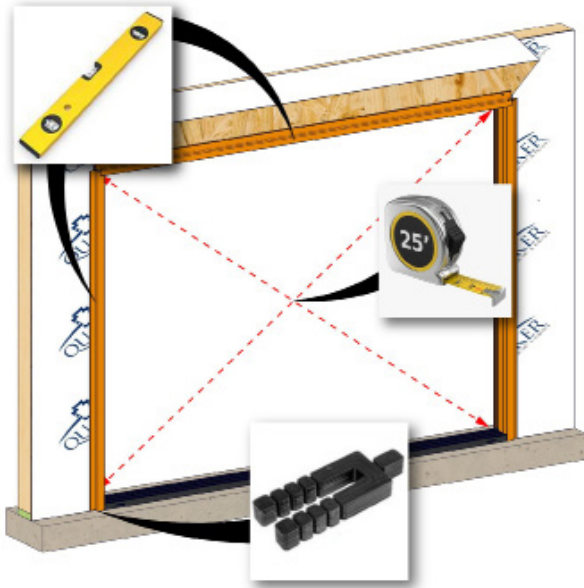

Square, level, and plumb the frame. Adjust shims as needed until diagonal measurements are within 1/8". Shim behind the header and jambs as necessary.

30

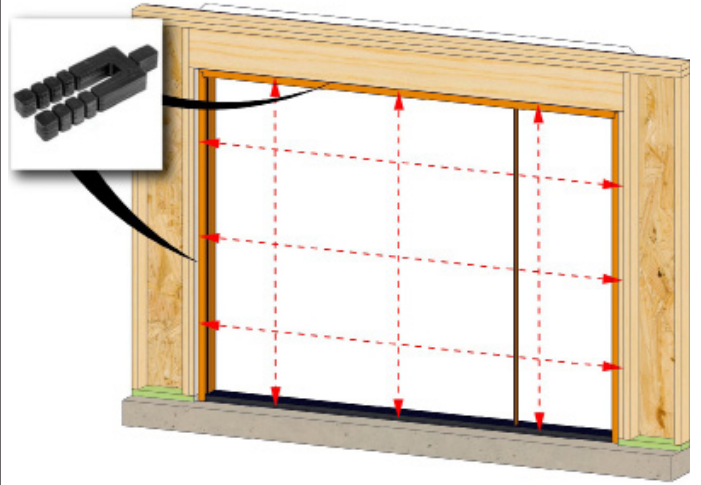

Check that the door frame is not bowed at jambs or head, a string line may be required. Adjust shims as needed but verify measurements are within 1/16".

31

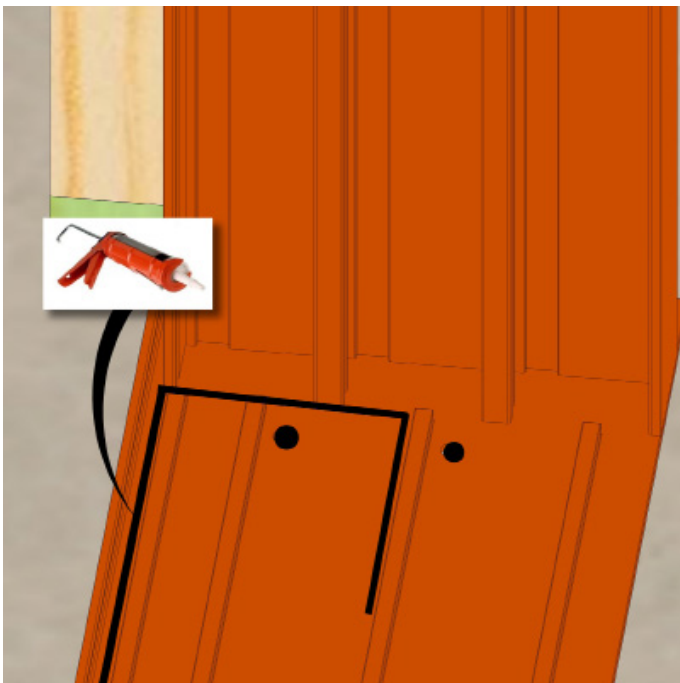

Run a bead of silicone along the wall, up the leg of the sill pan, and along the interior most leg the length of the sill pan.

Note: This will be the space between the lip of the sill pan and the first leg, as shown above.

32

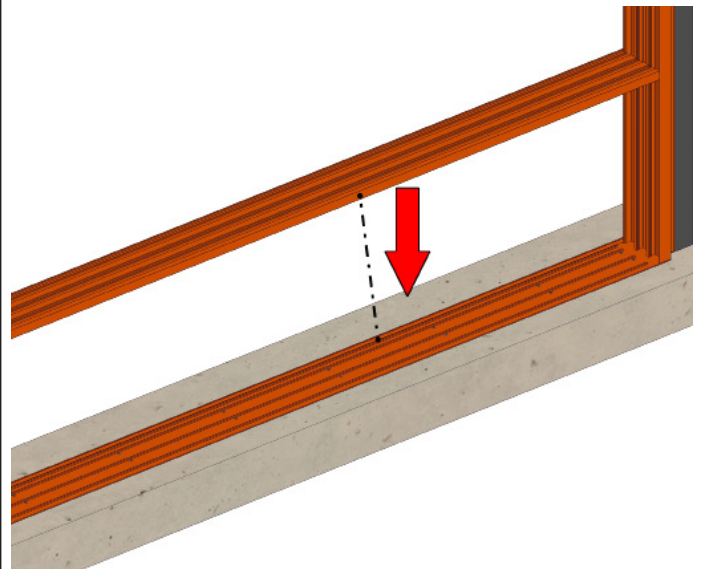

Make sure all foreign material is removed from sill and sill pan. Set the sill in place.

33

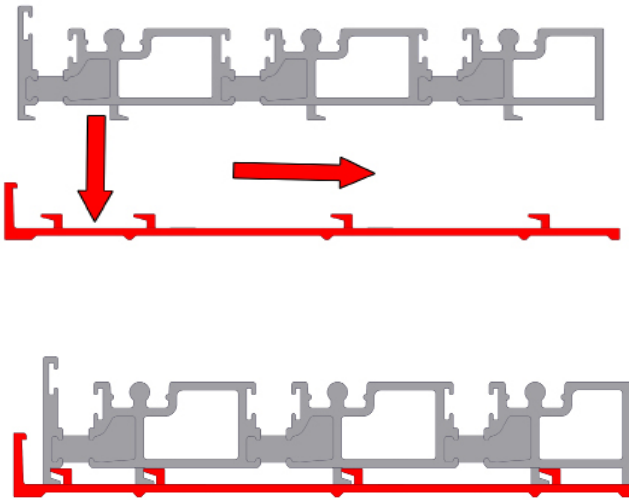

Push the sill down and then toward the exterior to lock in the sill to the sill pan.

34

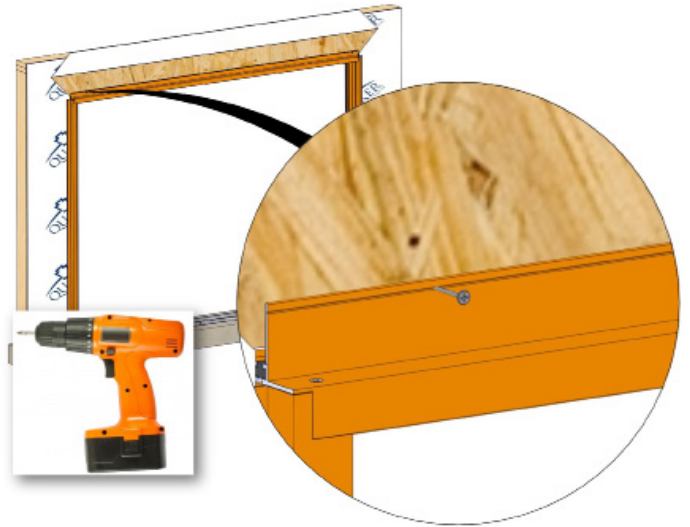

Fully fasten the screws down now to hold the frame in place.

35

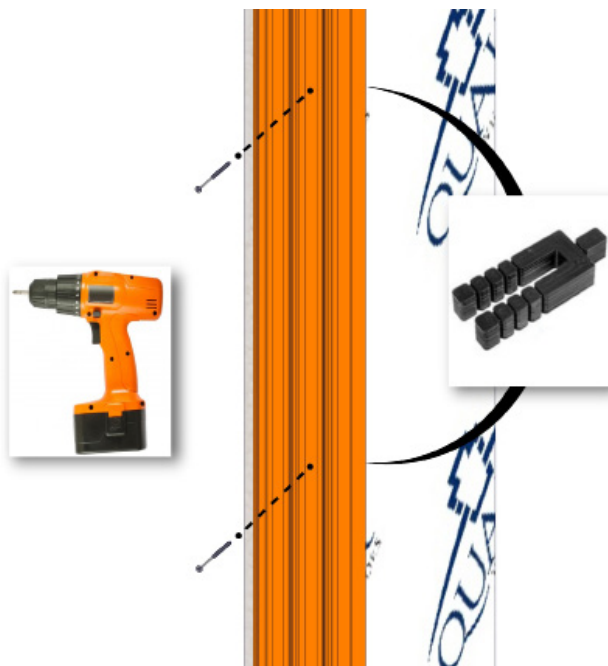

Fully fasten the screws down now to hold the frame in place. The holes through the center track of the header & jambs, typically 6" from ends and 24" on center for fasteners.

36

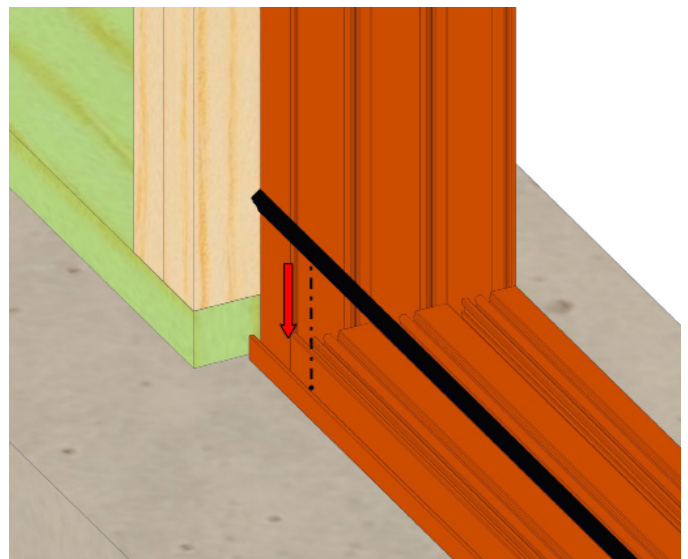

Locate the interior side of the sill. Push the sill down and towards the exterior to lock in place. Take the wedge gasket (Part #: 4874-02-00) and press in place. Note: This will run the whole length of the sill pan.

PANEL INSTALL

For panel install the process is the same no matter the amount of panels. You always start with the active (interior most) panel and end with the fixed (exterior most) panel.

37

Glazing Beads to Interior

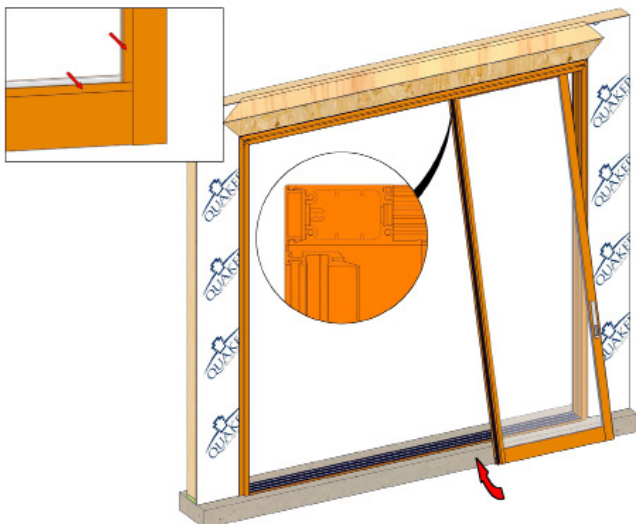

Active or Inactive Panel Shown

From the exterior, install the locking panel with the handle, by tilting the top into the inner most head track and setting the bottom of the panel in the inner most groove in the sill track.

- *Note orientation of interlock rails when choosing panels.
- *Note glazing beads are to the interior side.

38

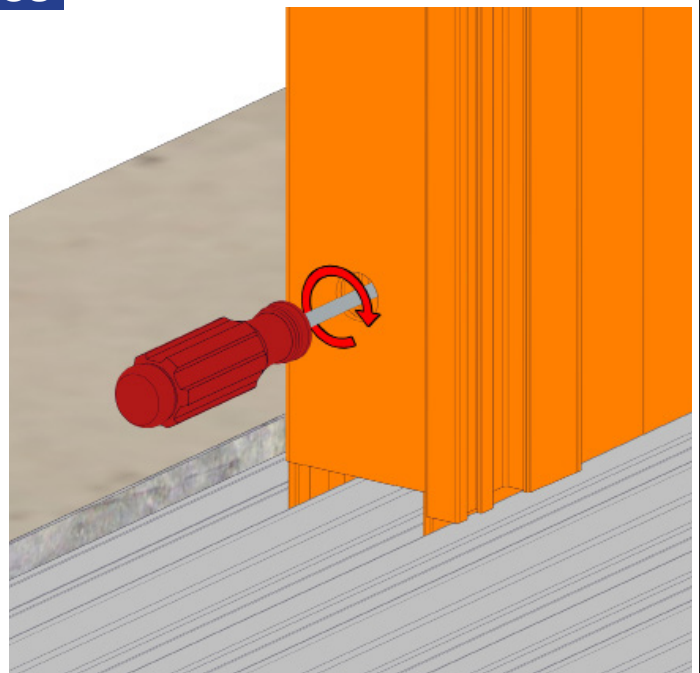

Use a #2 phillips screwdriver to engage the roller adjustment on both sides of a panel. Turn clockwise to raise the panel and provide smooth rolling. If possible, lift the panels slightly when adjusting to take pressure off the rollers. Roll panel back and forth 2-3 times to verify roller height is set. Repeat this step for each panel installed.

39

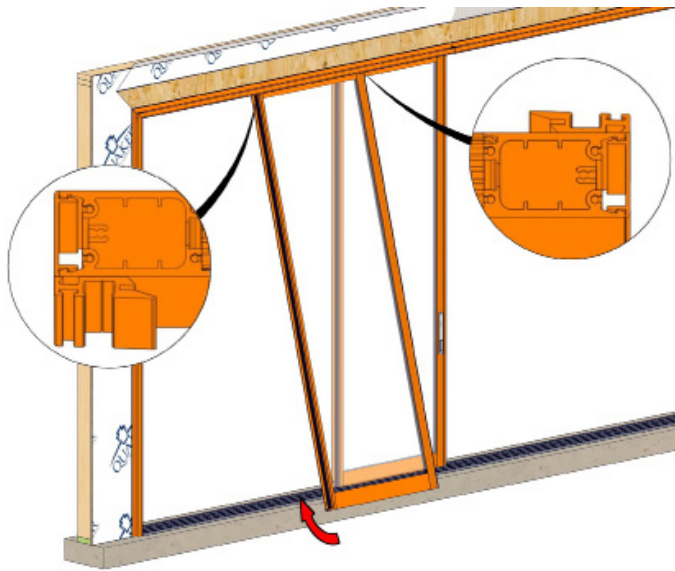

For the center panel on the left placing it in the center tracks. Make sure the panels are overlapped when installing so the interlocks will engage properly.

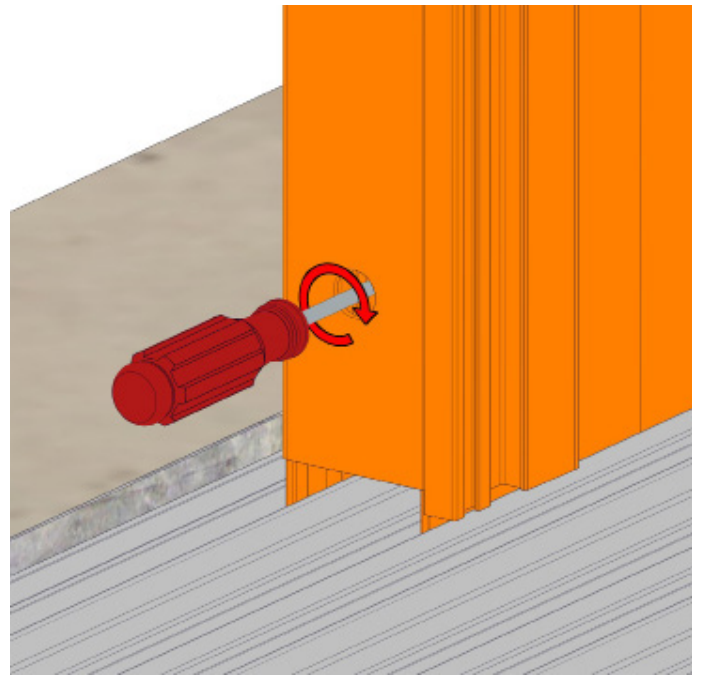

Use a #2 phillips screwdriver to engage the roller adjustment on both sides of a panel. Turn clockwise to raise the panel and provide smooth rolling. If possible, lift the panels slightly when adjusting to take pressure off the rollers. Roll panel back and forth 2-3 times to verify roller height is set. Repeat this step for each panel installed.

40

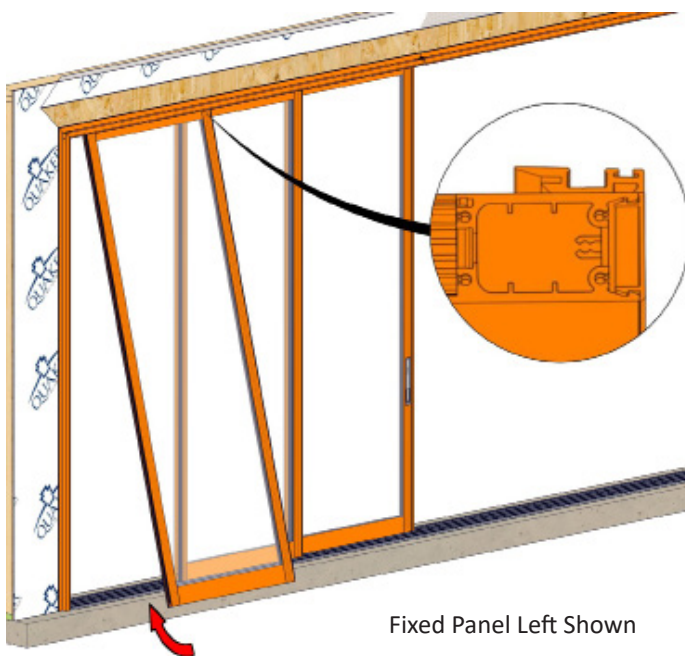

Repeat for exterior (fixed) panel, setting it into the exterior tracks in the head and sill. Make sure the panels are overlapped when installing so the interlocks will engage properly.

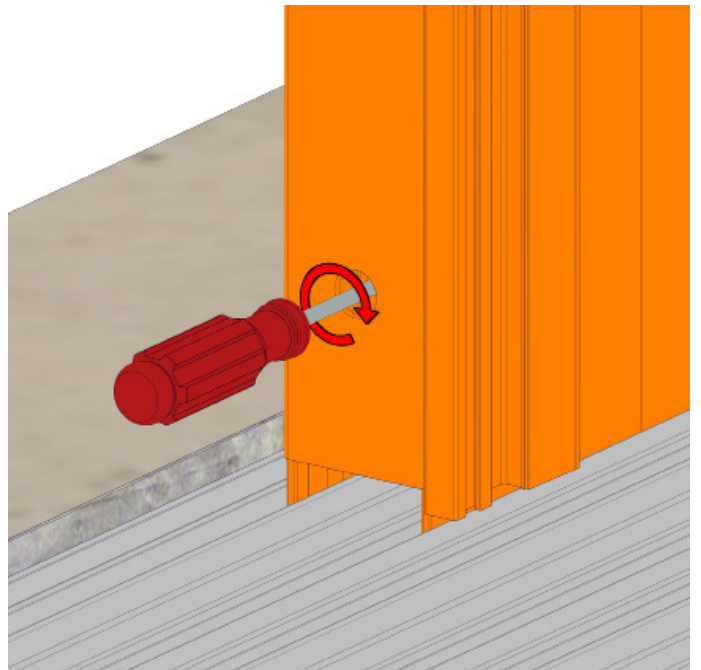

Use a #2 phillips screwdriver to engage the roller adjustment on both sides of a panel. Turn clockwise to raise the panel and provide smooth rolling. If possible, lift the panels slightly when adjusting to take pressure off the rollers. Roll panel back and forth 2-3 times to verify roller height is set. Repeat this step for each panel installed.

40

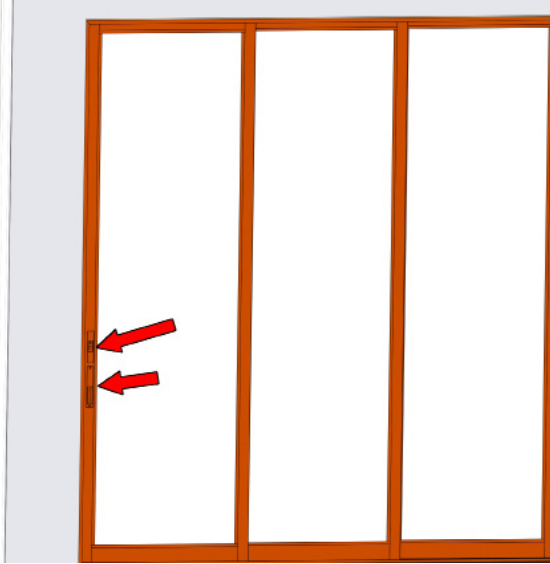

Adjust active panel level, get to lock and then adjust other panels. (The active panel is the panel with the handle set, and the interior most panel.)

41

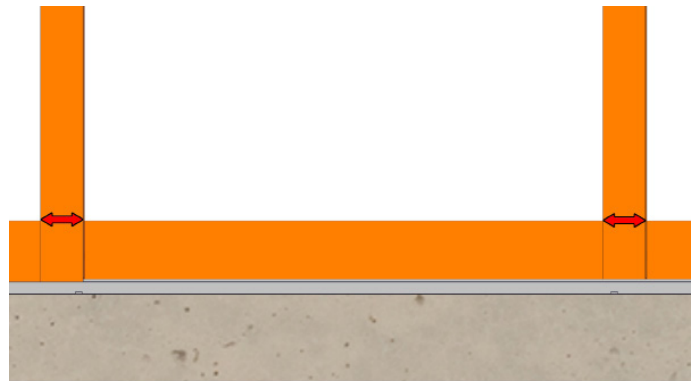

Adjust rollers on all panels so they roll smoothly. Check the reveal of the glass at the top of panels and adjust as needed to line up all panels.

42

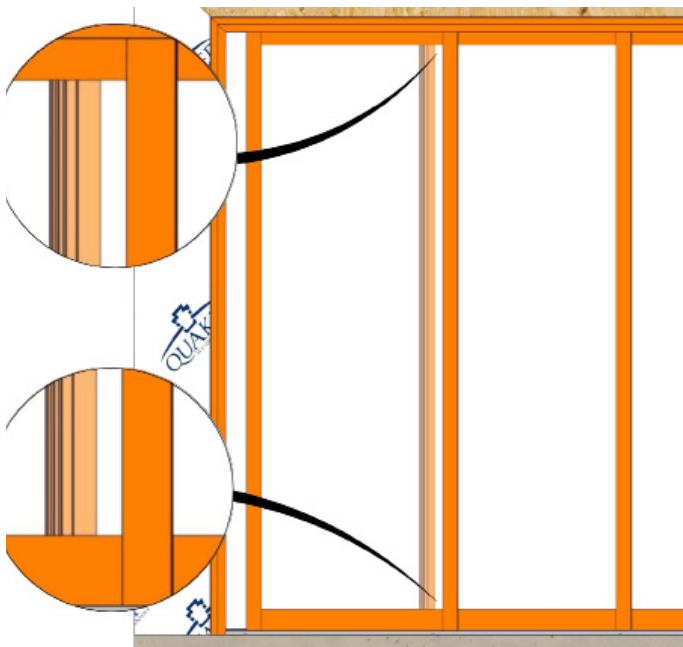

Slide each set of panels apart to check that the reveal matches at the top and bottom. Adjust rollers as needed to match reveal across panels.

43

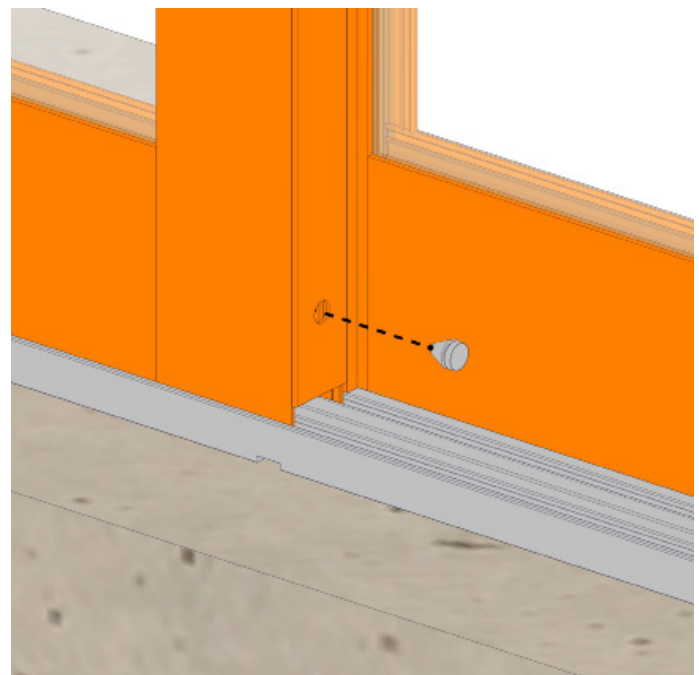

Once all panels have been adjusted install the panel bumpers (Part #: 9309K86) into each roller adjustment hole.

44

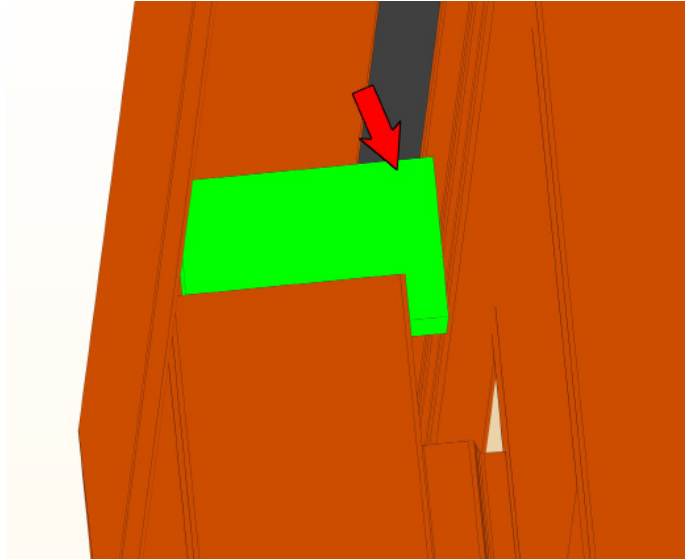

Slide the fix panel fully into the frame jamb, then take the frame head dust plug and remove backing. Slide the dust plug in between the head and the top of the fixed panel. The edge of the panel and the face of the dust plug should be flush. Each panel should get a dust plug.

45

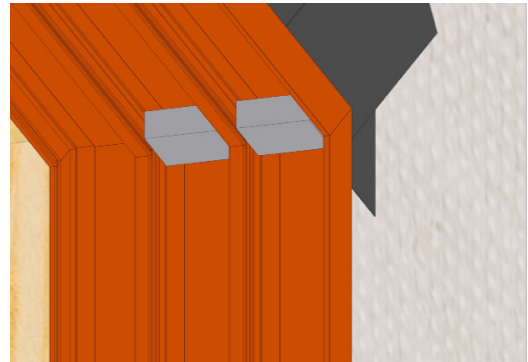

Place 1 dust plug in each track where the heads meet, as shown in the picture above, except the locking panels.

46

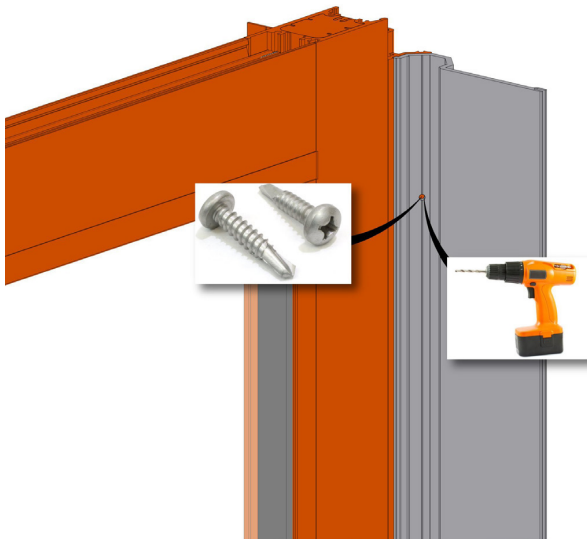

Drill a 1/8" hole 3" from each end and then 12" on center. Install fasteners (PSP8AX1/2) in each hole.

47

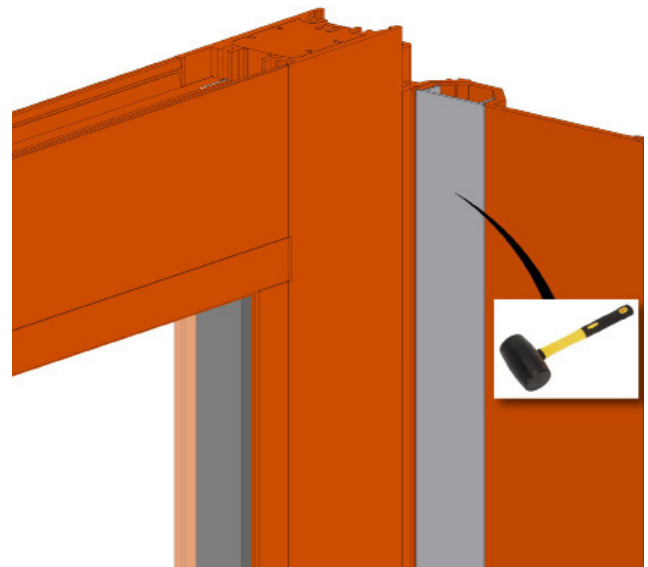

Next install the pocket closure cover with a rubber mallet. Be care not to dent the cover or closure.

Exterior Closure Install

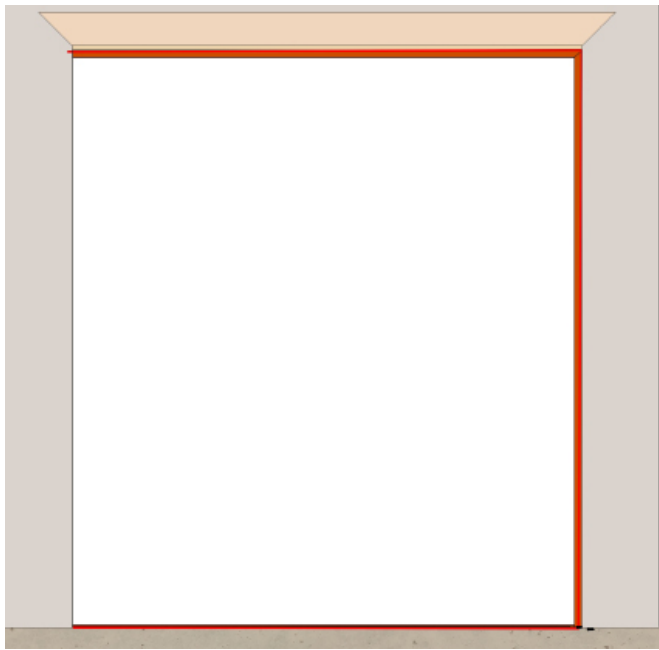
48

Run a cap bead around the exterior of the door system. Start inside the wall on the exterior, along the head, down the jamb and across the flashing pan.

NOTE: BE SURE NOT TO COVER THE WEEPS!

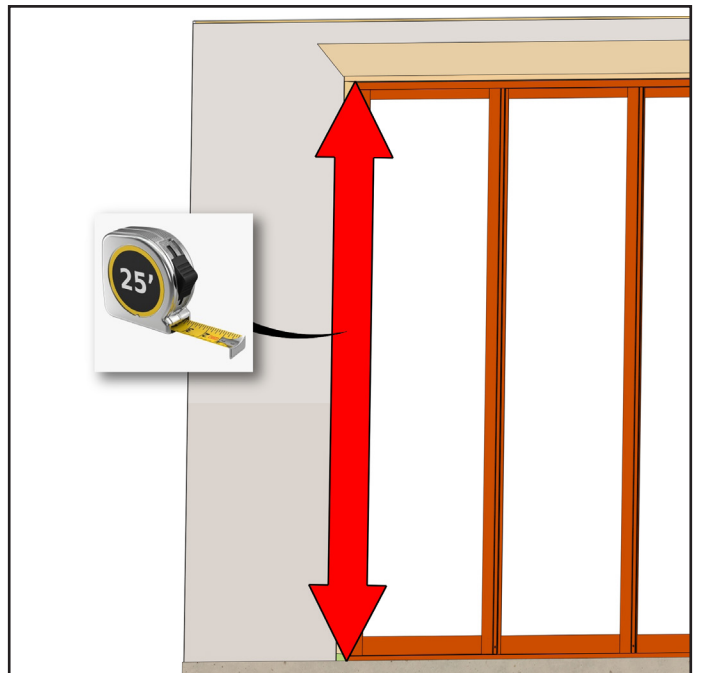
49

On the exterior side of the door, where the pocket starts, measure from the top of the head to the bottom of the sill pan.

50

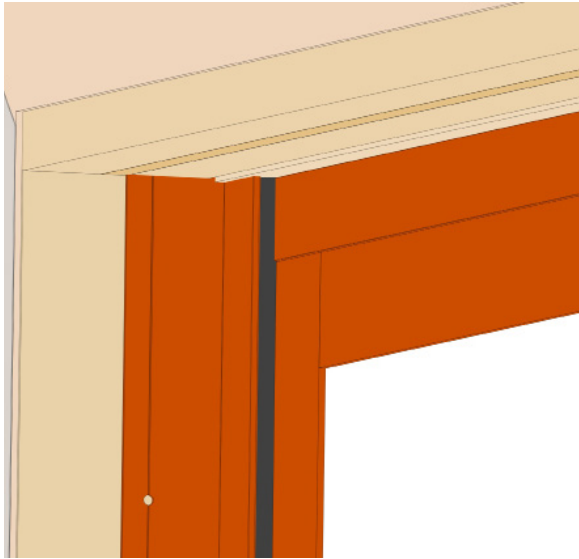

Take the exterior closure interlock (Part #: M25389) and cut it to length. Lock the door system. Rough fit it in the opening, and shim if necessary. If unable to lock, the closure needs to be shimmed out toward the lock. If door system locks, but panels are loose and not fully interlocked, need to remove shims from behind closer to move closure away from the lock.

51

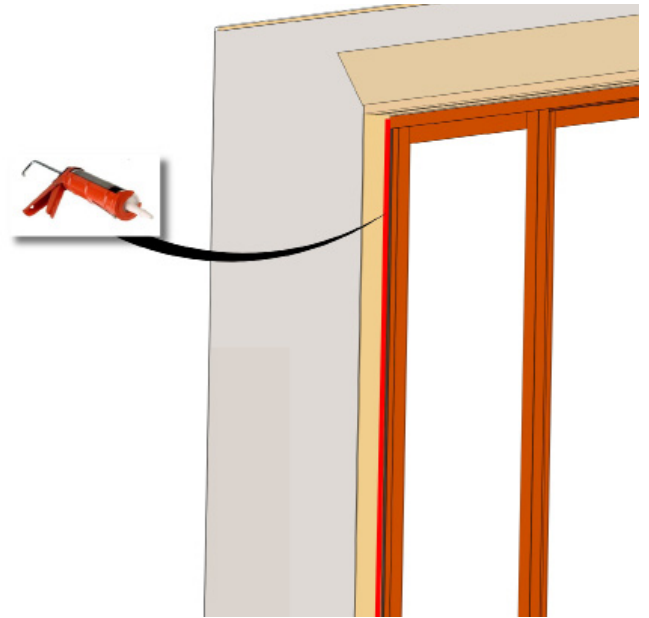

Apply a 3/8" bead of sealant under where the exterior closure will be installed. Closure will run from head to sill. Install the closure.

52

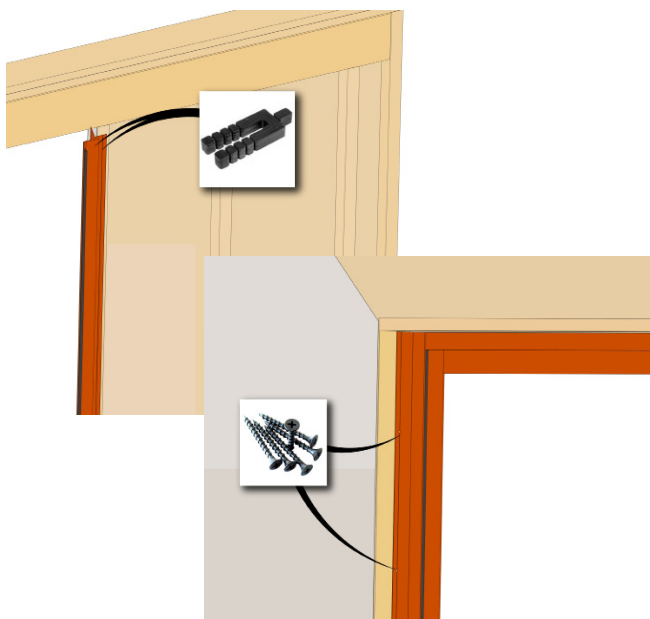

Shim behind the closure so that the closure hits along the whole interlock. Closure can be shimmed in both direction. Fasten the closure to the wall, 3" from each end and 12" on center. BE SURE ALL INTERLOCKS ARE ENGAGED AFTER CLOSURE IS MOUNTED.

53

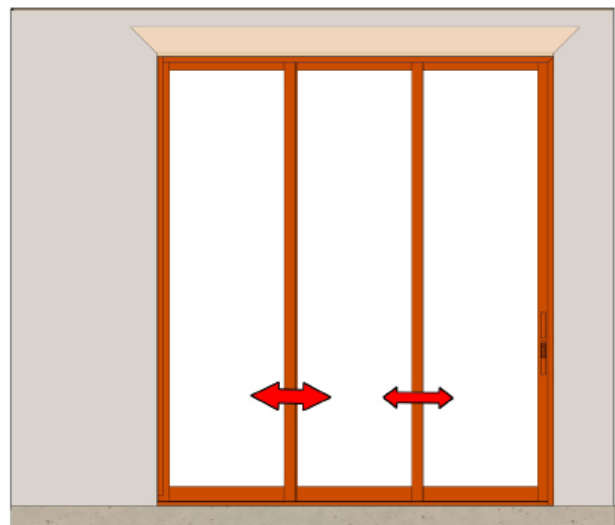

WHEN DOOR SYSTEM IS FULLY LOCKED THE PANELS SHOULD HAVE MINIMAL LEFT TO RIGHT PLAY.

54

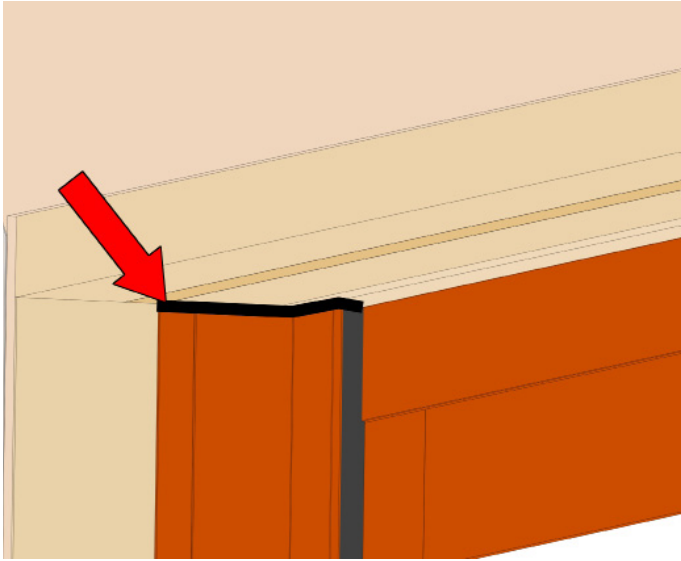

Silicone the joint at the head and sill.

55



Check to ensure a continuous bead of sealant at the exterior base of the sill. Be sure to not block the weeps on the bottom of the sill.

Frame Covers

56

Exterior

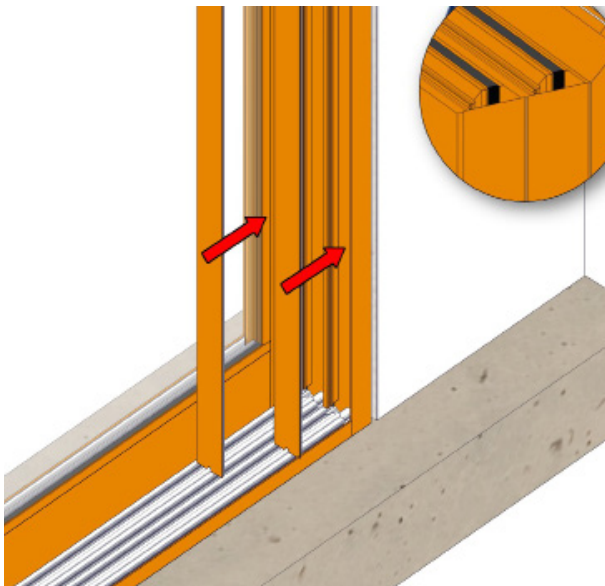

On the exterior jambs of the door, install two frame jamb covers - one in the middle track and one in the outermost track. Trim to fit. If a mallet is needed to install the jamb covers, use a wood block in between. **DO NOT HIT THE JAMB COVERS DIRECTLY!**

57

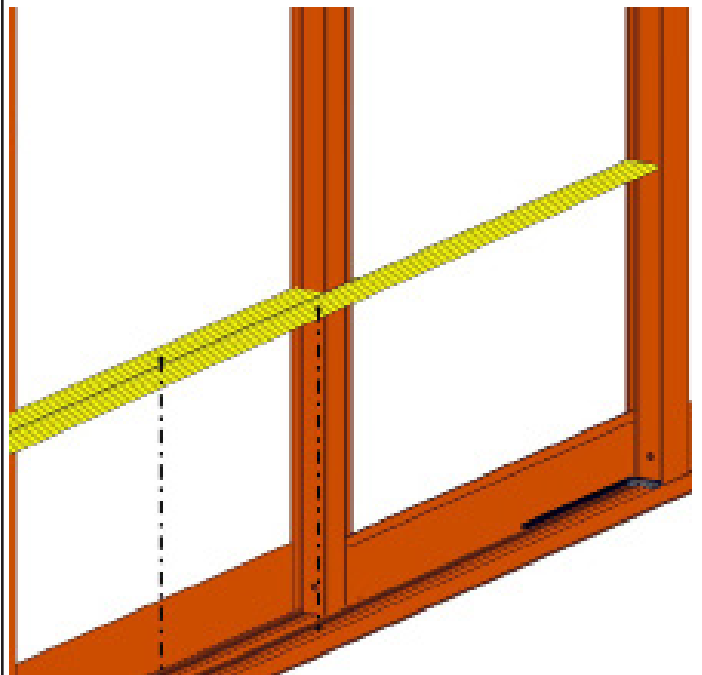

Lay out sill cover before installing, start with the sill cover closer to the interior.

58

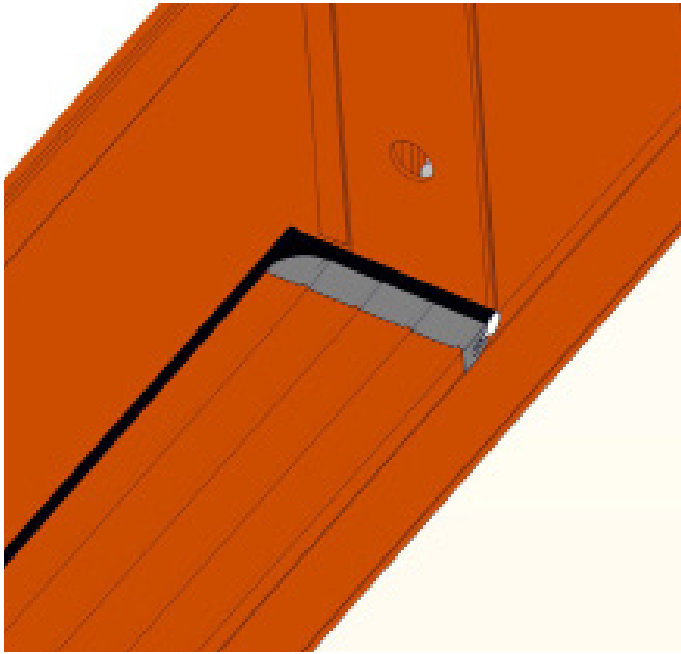

Take the sill covers and cut the end of the cover that doesn't have the molded part on the end.
(Molded part end is shown above in gray.)
NOTE: ON ACTIVE PANEL MEASURE FROM PANEL TO FRAME AND SUBTRACT 1/16", CUT, THEN PLACE AGAINST FRAME.

59

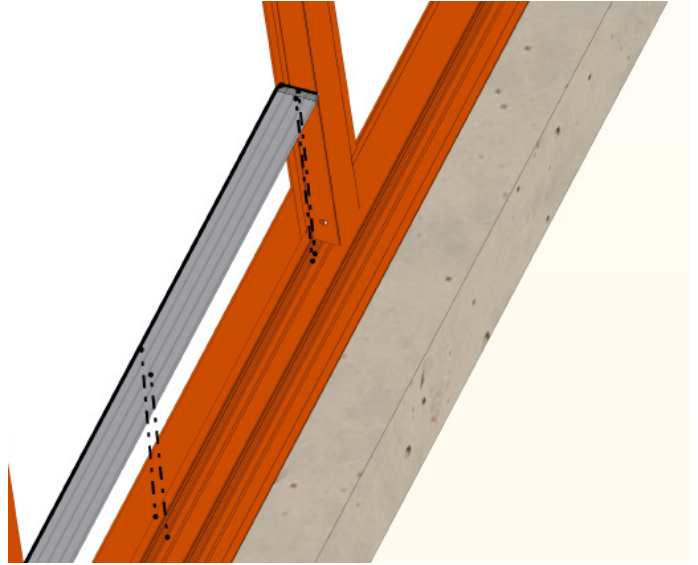

Install the interior sill cover.
DO NOT HIT THE SILL COVERS DIRECTLY DURING INSTALL!

60

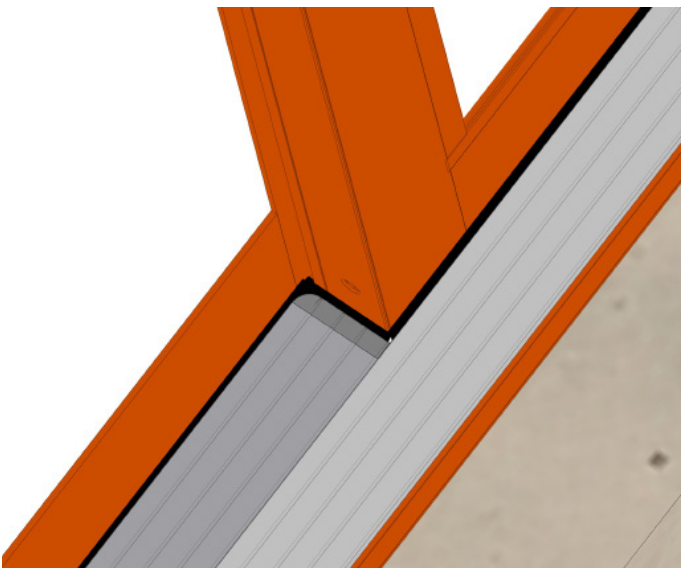

On the exterior sill cover, cut away the weather strip where it meets the sill cap you just previously installed.
NOTE: ON FIXED PANEL MEASURE FROM PANEL TO FRAME AND SUBTRACT 1/16", CUT, THEN PLACE AGAINST FRAME.

61

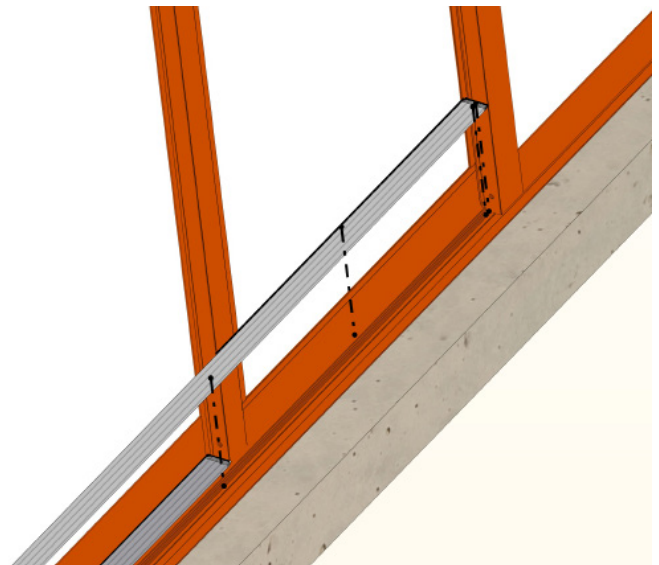

Next install the exterior sill cover.
DO NOT HIT THE SILL COVERS DIRECTLY DURING INSTALL!

62



Next install the short and long header covers in the exterior and middle tracks. Trim covers to fit if needed.

DO NOT HIT THE HEADER COVERS DIRECTLY DURING INSTALL!

NOTE: ON ACTIVE PANEL MEASURE FROM PANEL TO FRAME AND SUBTRACT 1/16", CUT, THEN PLACE AGAINST FRAME.

Interior Closure Install

63

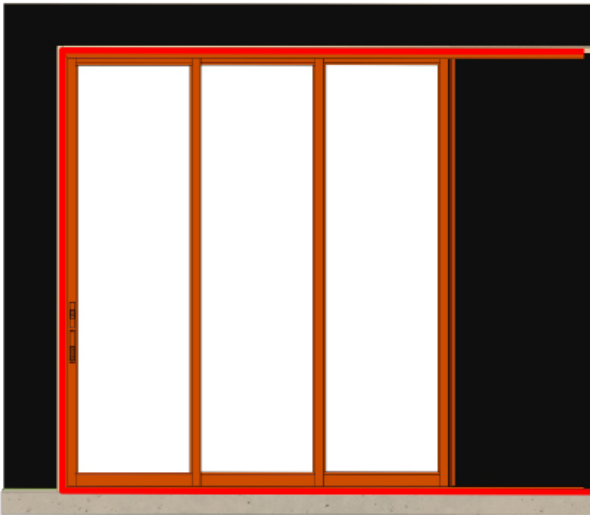

Run a cap bead of silicone around the interior side of the door.

64

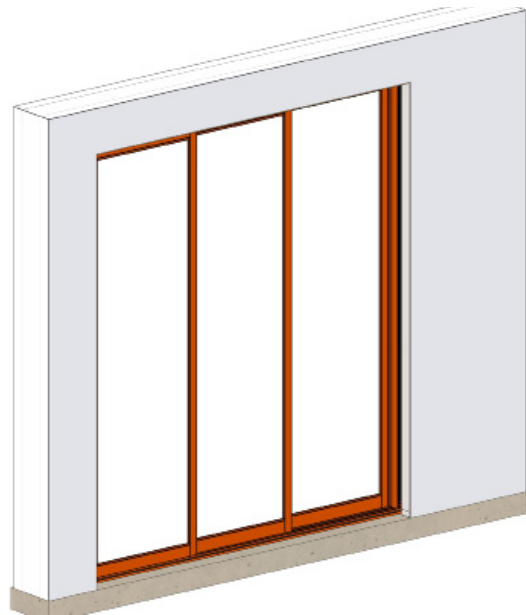

Build interior wall. Leave 3/4" space between the frame and black board.

65

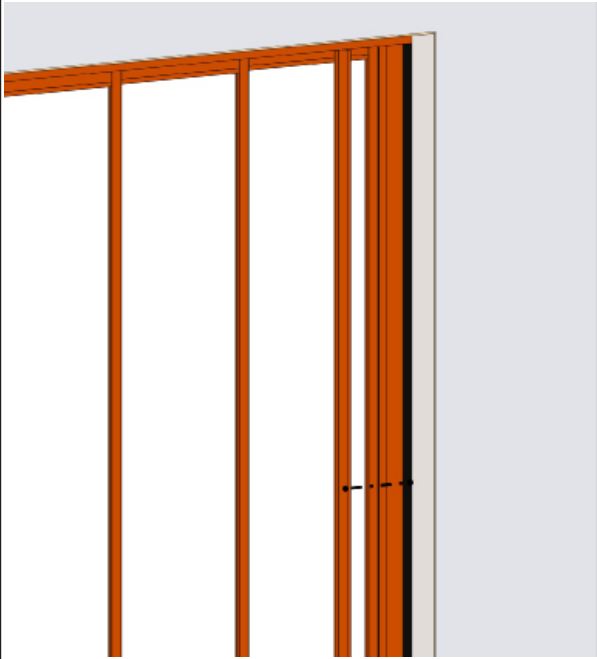

The interior closure will also run from the top of the head to the bottom of the sill.

66

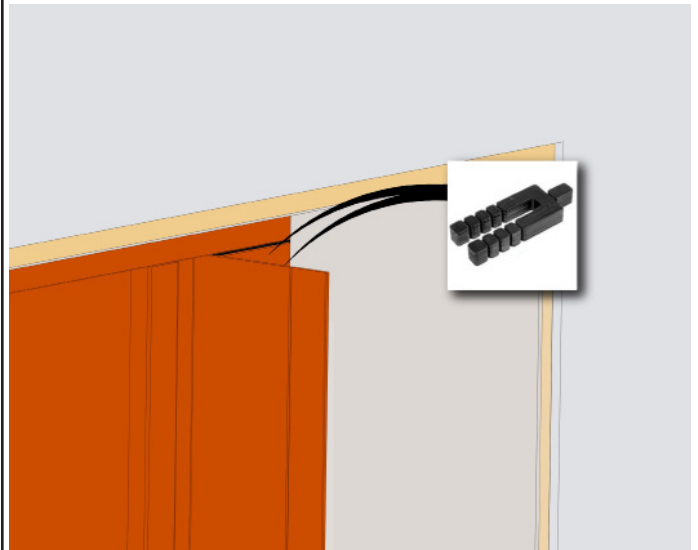

Shim the interior closure out so that the panel and closure seals.

67

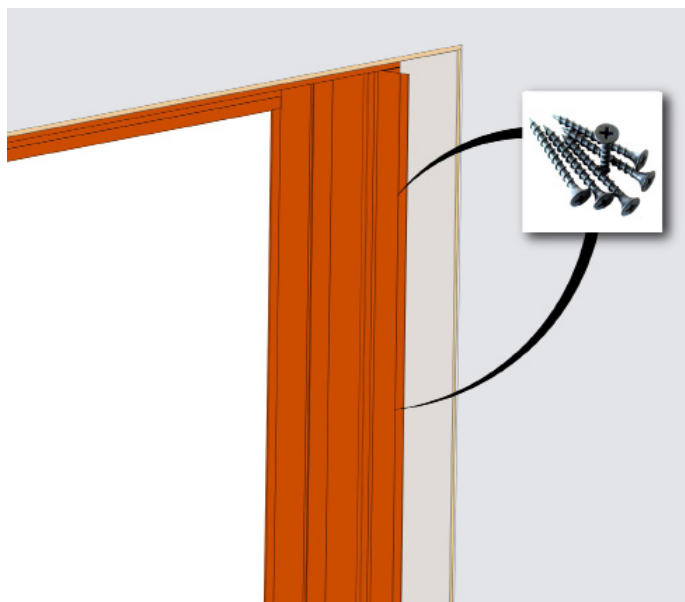

Fasten the closure to the wall with screws, 3" from each end and 12" on center.

Finish the interior right up to the closure.

Weather Proofing

68



Apply flashing tape at the sides of the door as shown. Smooth using a J-roller. Extend tape a minimum of 2" past door frame, but not more than the thickness of the flashing tape.

69

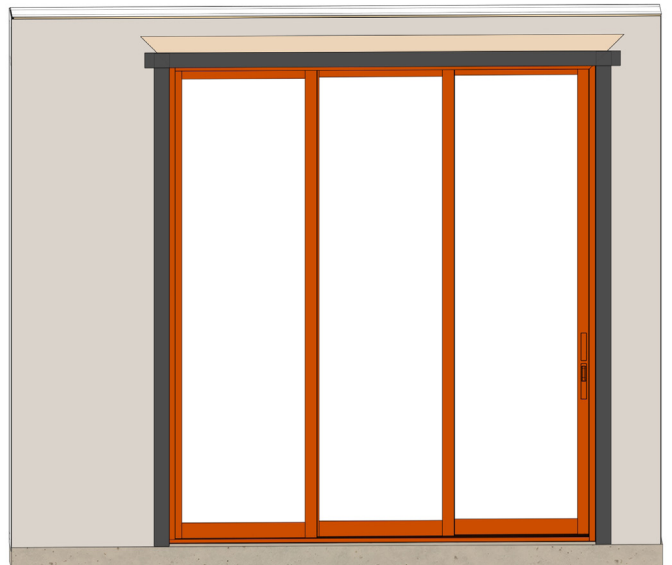

Apply a 3/8" sealant bead to the perimeter edge of door frame before installing the drip cap.

Apply flashing tape over the drip cap leg, overlapping the side flashing as shown. Smooth using a J-roller.



Side flashing cannot extend above the top flashing. Doing so could result in product or property damage.

70



Unfold the house wrap top flap and tape the angled seams as shown.

71

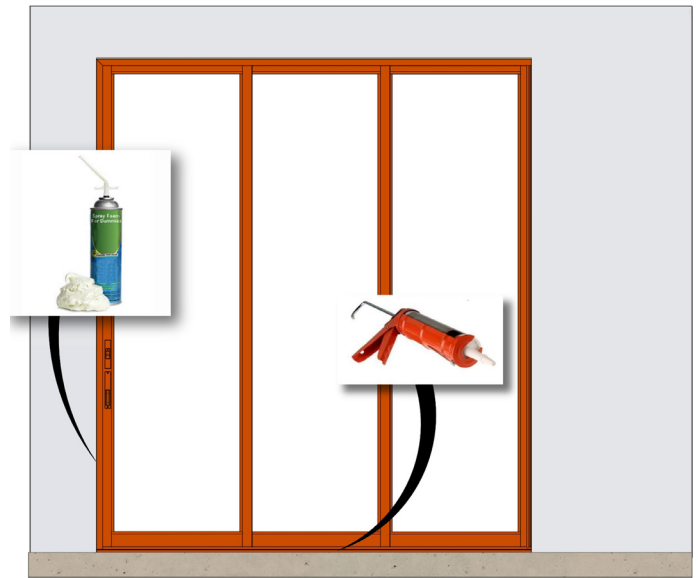

Insulate the gap between the door and framing with minimally expanding spray foam, and seal the entire interior perimeter with sealant.

72

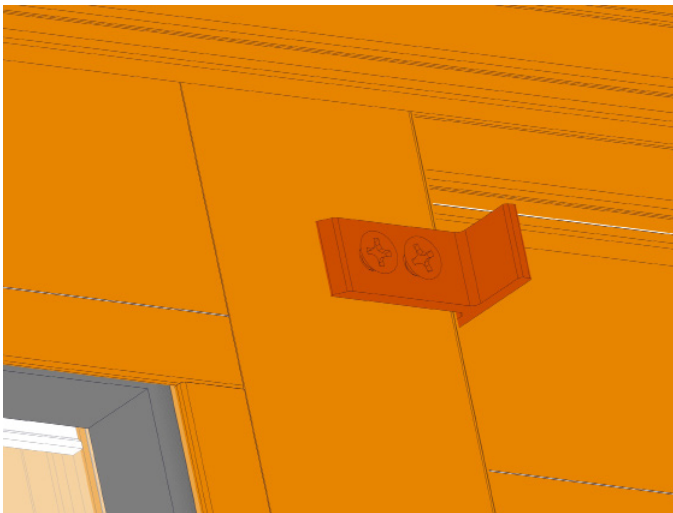

On the interior side of the middle panels, take the panel pickups (Part #: M25296-PCS) and #10 screw (Part #:MF10AX1) that is provided. Take screws and attach the pickups. Install the panel pickup where the holes are already fab'd on the interior side of the door.



Installation Guidelines

For Multi-Slide M2055 Pocket Door with Weather Resistant Barrier Installed

If this set of instructions doesn't match your installation method or wall conditions please check our website listed below for other options, or call the office.

Scan here for a digital version of these guidelines in English



Or go to: <https://www.quakerresidentialwindows.com/professionals/installation-instructions/>

Scan here for a digital version of these guidelines in Spanish

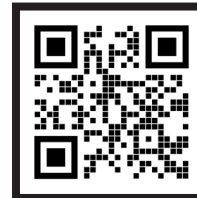

Or go to: <https://www.quakerresidentialwindows.com/professionals/installation-instructions-spanish/>

