



PO Box 128 | 504 Highway 63 South | Freeburg, MO 65035 | 800-347-0438 | 573-469-4151 (fax)

M-Series Terrace Door Transition T-Mull Installation

Read these instructions completely before starting any installation. Failure to install and maintain our product according to these instructions may void any product warranty. Please visit our website at www.quakerwindows.com or call 1-800-347-0438 for additional information.

Tools required by installer:



Materials required by installer:



Quaker supplied parts:

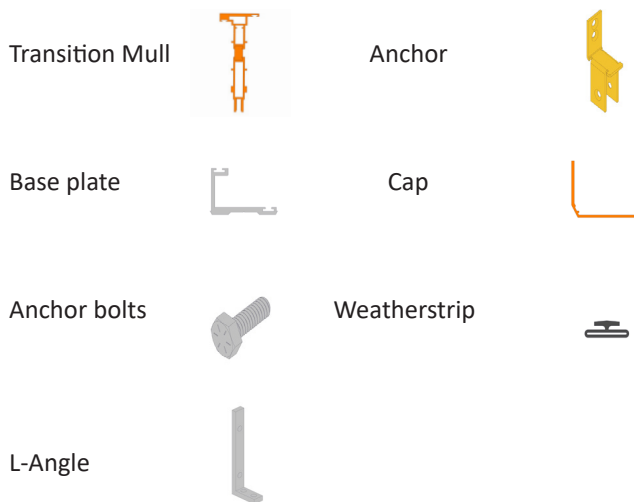

See last page for more details

⚠ WARNING

Tools

- Follow manufacturer's instructions for safe operation of tools, and ladders/scaffolding. Always wear safety glasses. Failure to do so could result in injury, product or property damage.

Handling

- Do not store units outside, or in a hot environment. Doing so could result in product damage.
- Do not carry flat.** Doing so could result in product damage, injury, or property damage.
- Stack units as straight as possible to avoid bowing. **Do not lay flat!**

Glass

- If broken, glass can fragment causing injury. All Quaker products are available with safety glass. In many areas, local building codes require safety glass in certain locations and/or applications. Unless safety glass is ordered, Quaker windows are not provided with safety glass. Before ordering, consult your local building codes for more definitive information.

Fastening

- Metal fasteners and components could corrode when used with preservative-treated lumber. Use approved fasteners and components to fasten window or door. Failure to do so could cause a failure resulting in injury, product or property damage.
- Fastener must attach to a structural framing member with 1 1/2" minimum fastener embedment, or minimum 3 full threads with a minimum 5/16" head as products were tested with.
- Quaker does not supply anchorage/fastener calculations, and is not responsible for determining structural adequacy of the anchorage and fasteners used to install our products, or the openings into which they are installed.**
- Do not** over drive screws or nails. Doing so could result in product damage.

 **CAUTION**
Installation

- Always support window or door in opening until fully fastened. Failure to do so could result in the window or door falling out or causing injury, product, or property damage.
- Nailing flanges and drip caps (integral or applied) **do not** take the place of window flashing. All windows and doors must be properly flashed and sealed with material compatible sealant for protection against water and air infiltration around the entire perimeter. Failure to do so could result in product or property damage.
- **Do not** set window directly on sill plate. Place shims under the side jambs. Window or door must be properly shimmed. Failure to do so could affect operation and product performance and could result in product damage.
- Live or dead loads transferred into our product can affect functionality, damage frame joinery or cause glass failures. Dead loads such as upper levels, roof, etc. Should be constructed before window or door is installed.
- Loads shall be designed to withstand the most critical effects of load factors and load combinations as required by the building code. (Loads are including but not limited to Live, Dead, Collateral, Auxiliary, Thermally induced, Seismic, etc.)
- Maximum vertical deflection of the header under all Load combination should not exceed the Span/720 or 1/4" whichever is less.
- Windows and doors have small parts. Small parts if swallowed could pose a choking hazard to young children. Dispose of unused, loose, or easily removed small parts. Failure to do so could result in injury.
- **Do not** drill through or into window sill to install alarm wires.

Sealing

- Follow instructions of foam, sealant, and flashing manufacturers regarding safety, material application, compatibility, and periodic maintenance for continued weather resistance of their products. Failure to do so could result in product or property damage. **DO NOT** overfill between the frame and opening.
- Minimally expanding foam insulation must be compliant with AAMA 812-19.
- Quaker recommends 100% silicone (ASTM C920 compliant) neutral cure only sealant. Always clean all areas where sealant will be applied. Failure to do so could result in product or property damage.
- Flashing tape must meet ASTM-D779 performance requirements.
- Maintain a minimum of 1/4" between the window or door frame and exterior finish materials. Failure to do so could result in product or property damage.

Joining

- Do not join any window or door to any window or door not designed for joining. Joined windows and doors must be individually supported in the opening. Failure to do so could affect operation and product performance and could result in product or property damage.

Cleaning

- Acid solutions used for cleaning will damage glass, fasteners, hardware, and metal flashing. Protect these products and follow cleaning products manufacturers instructions. If acid contacts the window or door, wash all surfaces immediately with clean water.
- **Do not** use razor blades to clean glass surface. Glass damage could result.
- Clean glass using liquid glass cleaner.
- Clean frame, sash, panels, and insect screens using mild detergent and warm water with a soft cloth or brush.

IMPORTANT

- Buildings constructed prior to 1978 could contain lead paint which could be disturbed during window or door replacement. For more information on proper management of lead paint, go to: www.epa.gov/lead
- Care must be taken to properly recycle or dispose of old materials. Any recyclable materials should be separated from non-recyclable or hazardous materials. Please consult with local or state authorities regarding proper disposal of non-recyclable or hazardous materials.
- These are generic instructions intended to cover most common situations, which may not be appropriate for all installations due to building design, construction materials, or methods used and/or building or site conditions. Consult a contractor or architect for recommendations.
- Inspect all units for any damage or defects prior to installation. Contact the nearest Quaker distributor if there are any problems.

1

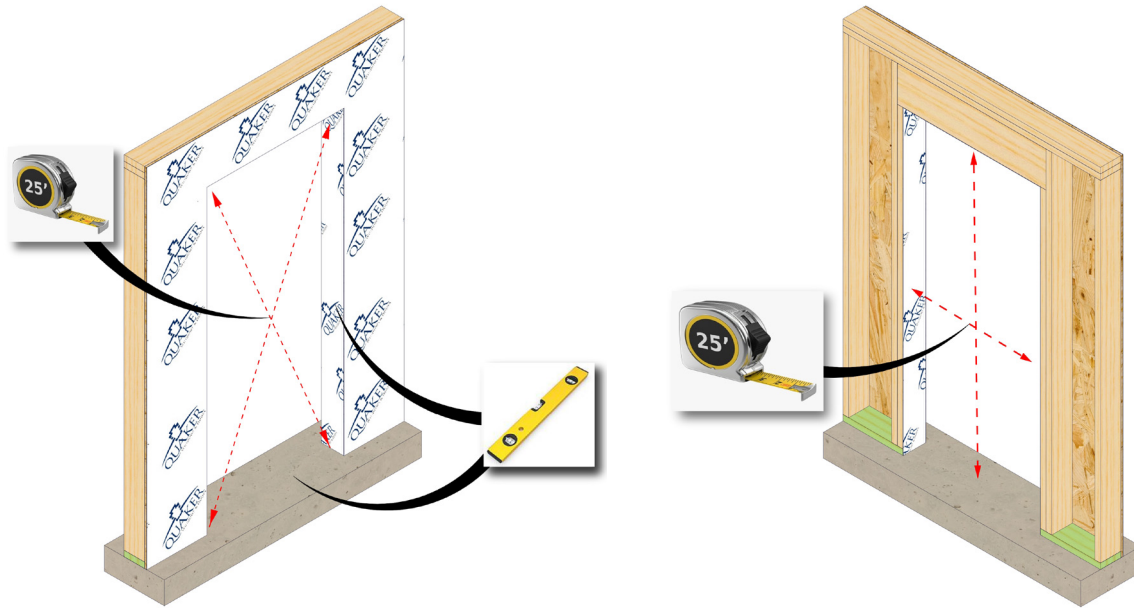

Measure and verify the size of the rough opening. The rough opening should be $\frac{3}{4}$ " wider than the unit, and $\frac{1}{2}$ " taller. Verify the rough opening is flat, plumb, level, and square. **The sill beneath the unit must be level for proper unit operation.** Check the fit of the sill pan flashing system making sure the conditions are level. The installer can pre-apply the shims to the sill condition prior to installation of the sill pan flashing system. When shims are applied, verify door unit will clear header. Adjustments to header and rough opening might be required when shimming under the door unit.

2

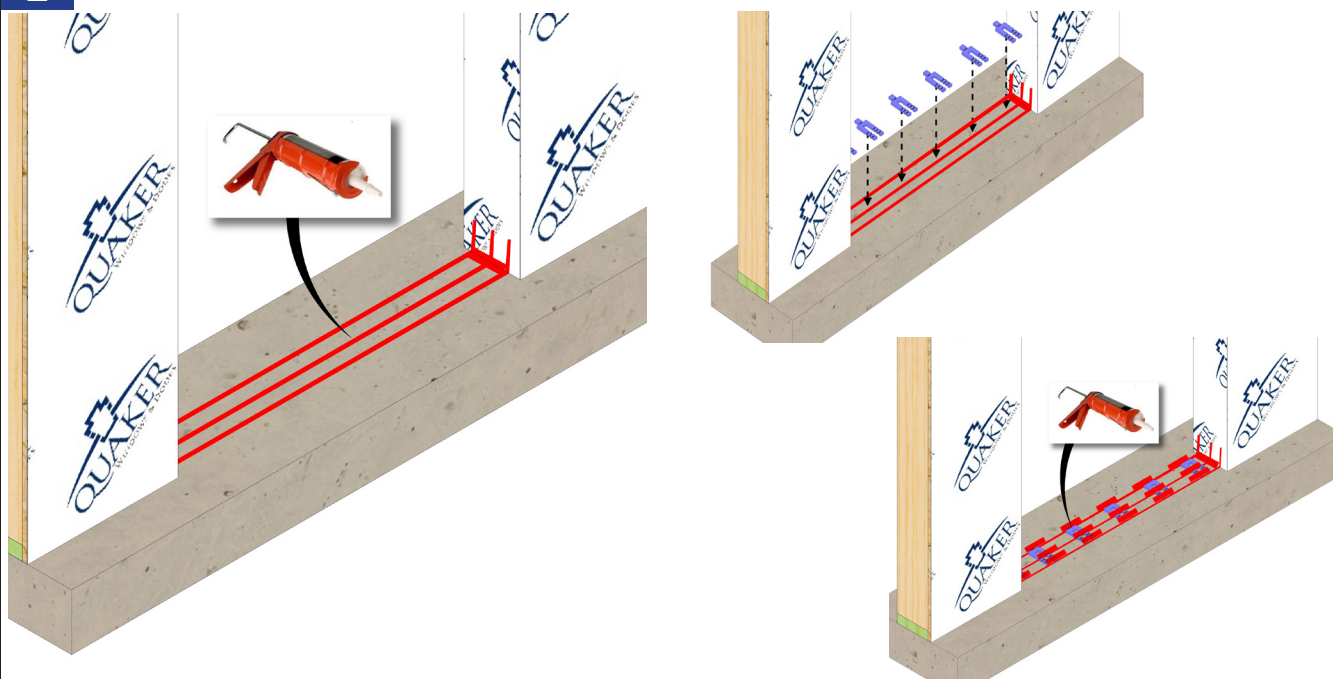

Apply three continuous $\frac{3}{8}$ " beads of sealant on the sill where the pan flashing will set. Also generously apply sealant along the bottom corners of the rough opening. Set shims in the bed of sealant and apply additional sealant over the top of the shims.

3

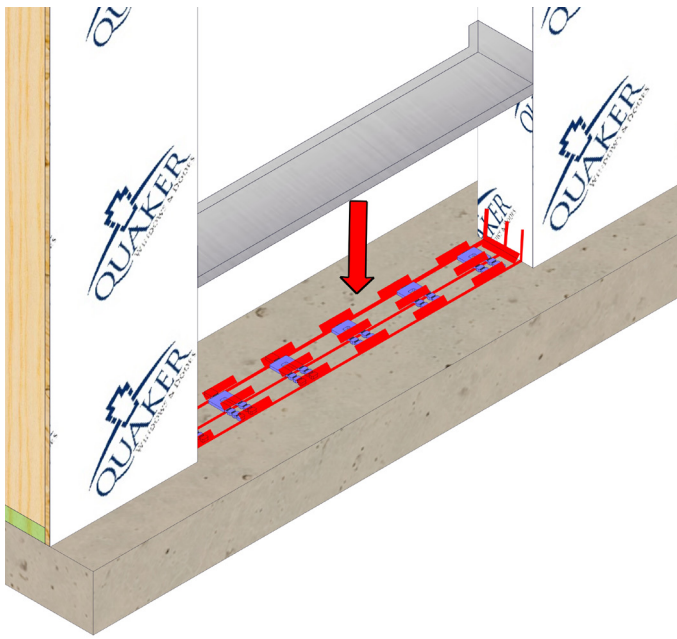

Apply sill pan flashing. The flashing must extend to the exterior face of the wall.

4

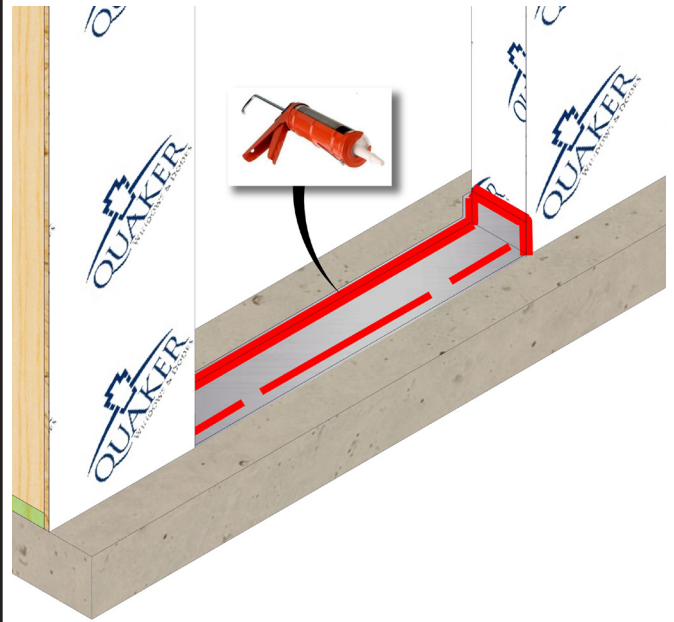

Apply a continuous bead of sealant to the exterior face of the upturned leg of the sill pan. Also seal where the sill pan flashing meets the rough opening, and tool sealant over any fasteners used to install the pan. Apply a discontinuous bead of sealant across the front of the sill pan flashing where the front of the unit will sit.

5

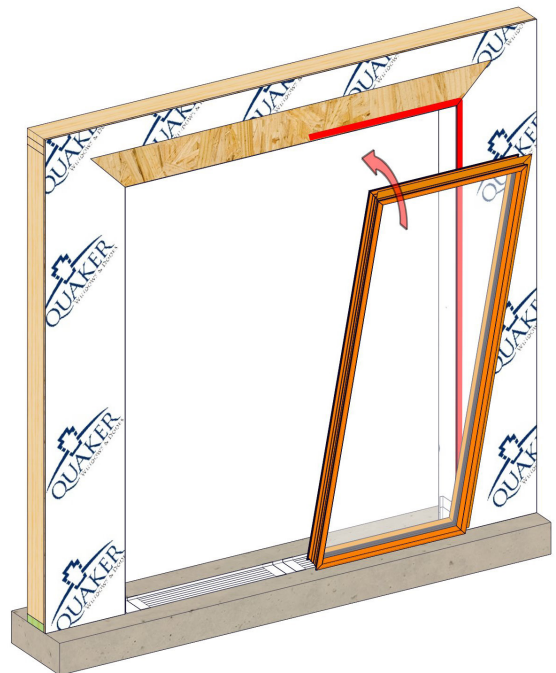
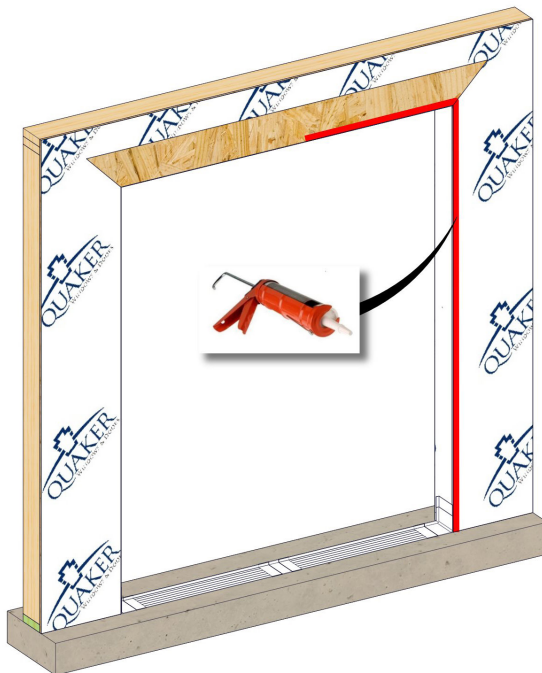

Apply a continuous 3/8" sealant bead at the side and the top of the opening where the window/sidelite will go, no more than 1/2" from the edge of the opening. Install window/sidelite in rough opening, lifting and setting the bottom of the unit in first, then tilting into place. Verify for squeeze out of sealant along nailing fin.

Refer to the standard nail fin installation guide (IG-001) for details on installing the unit.

6

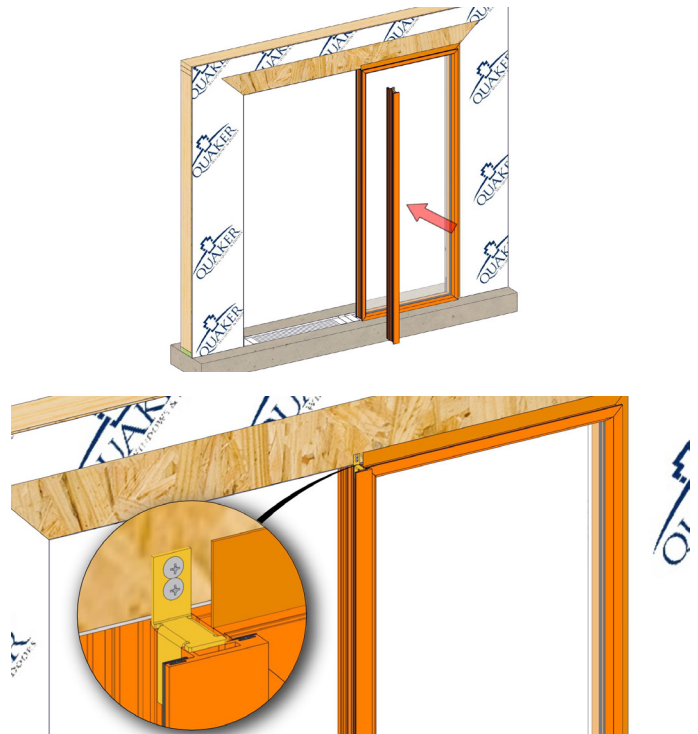
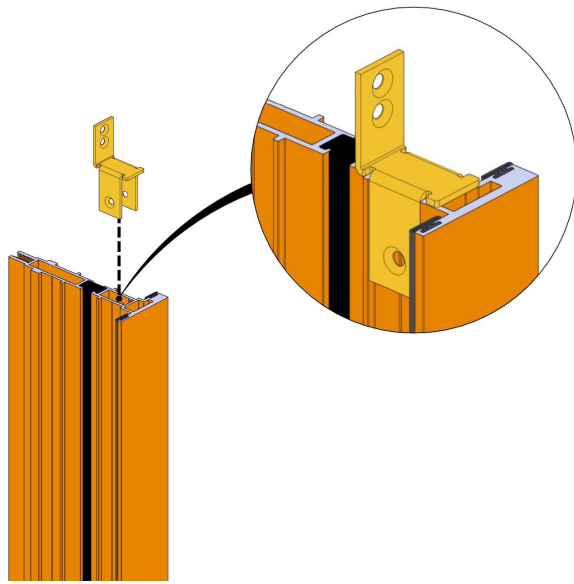

Install the anchor clip in the top of the T-mull as shown above. Install the transition mull so the anchor clip is to the exterior. Verify the mull is vertical and located in the opening with proper spacing between the door and window units per shop drawings (e.g. 1" spacing between door and window with a 1" mull). Fasten the mull anchor to the header on the exterior wall, typically with #12 x 1" screws supplied by others, per anchorage calculations or shop drawings.

7

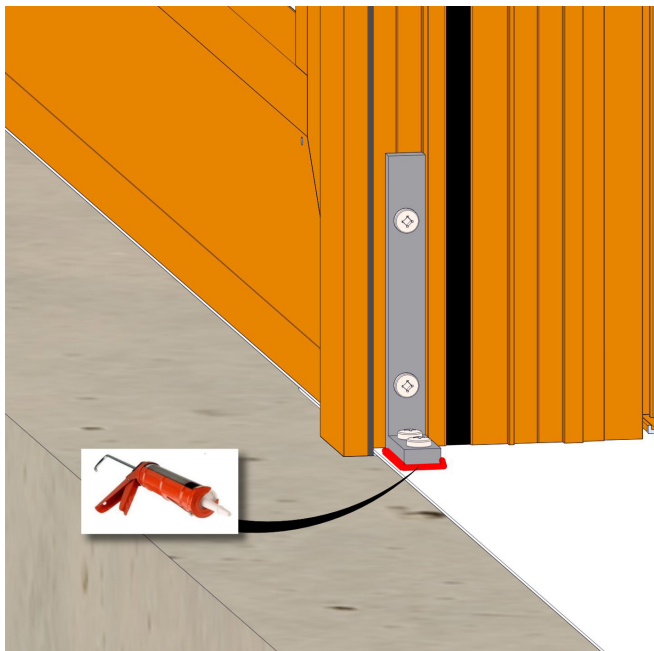

For all Installations: Verify transition mull is vertical and centered properly between the units being installed. Install L-angle at the sill in a bed of sealant with fasteners into sill, per shop drawings or anchorage calculations. Secure the L-angle to the transition mull at the sill with two self-tapping screws supplied by others, typically #12 x 1" screws.

8

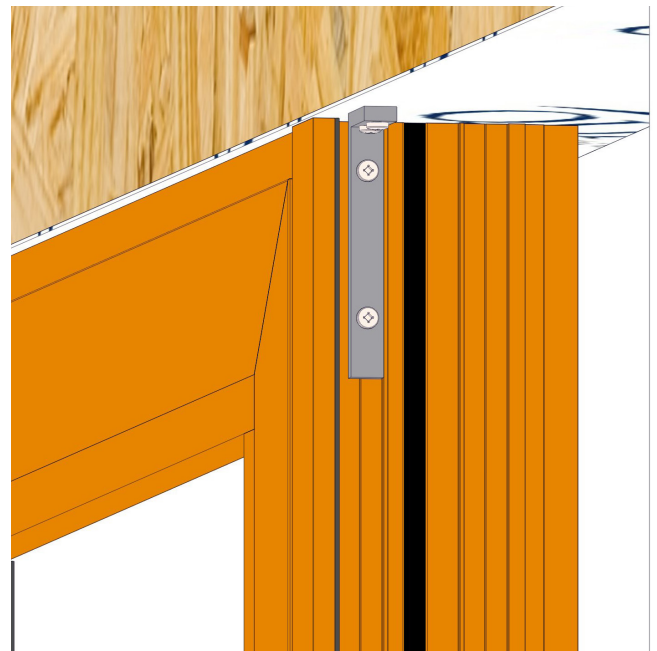

For Installations without Positioning Fin on Door and No Nail Fin on Window: An anchor clip is not used at the header. Verify the transition mull is spaced properly and vertical. Install the L-angle with fasteners into header, per shop drawings or anchorage calculations. Secure L-angle to the mull with self-tapping screws, typically #12 x 1" screws.

9

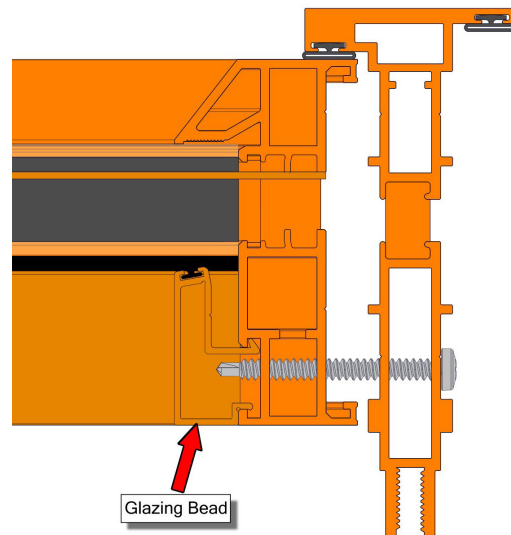

Drill pilot holes through the transition mull into the window/sidelite unit. Fasten through the mull into the window/sidelite, typically with #12 x 2" screws by others, spaced 6" from the top & bottom and 16" centers thereafter.

Take caution not to drill & screw into the glazing bead on the window/sidelite.

10

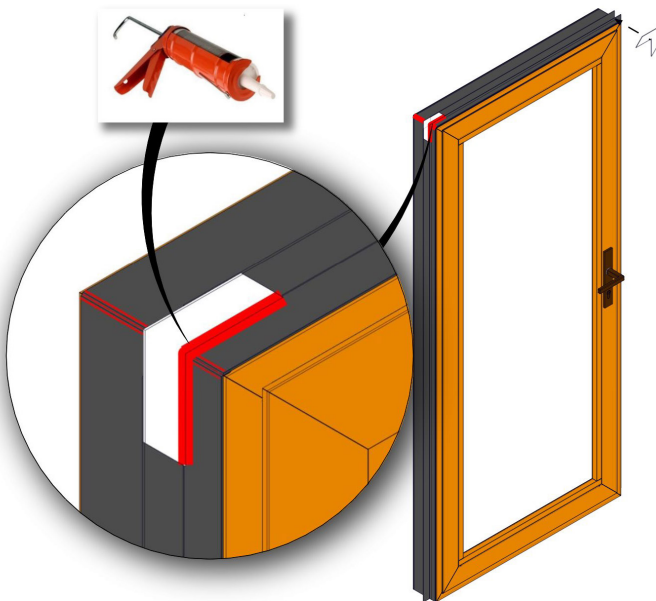

Install the top foam corner key gasket over the exterior side of the positioning fin corner gap on the door. Seal the exterior corner where the gasket meets the position fin as shown above.

Note: Prep the positioning fin according to IG-071 Terrace Door install instructions.

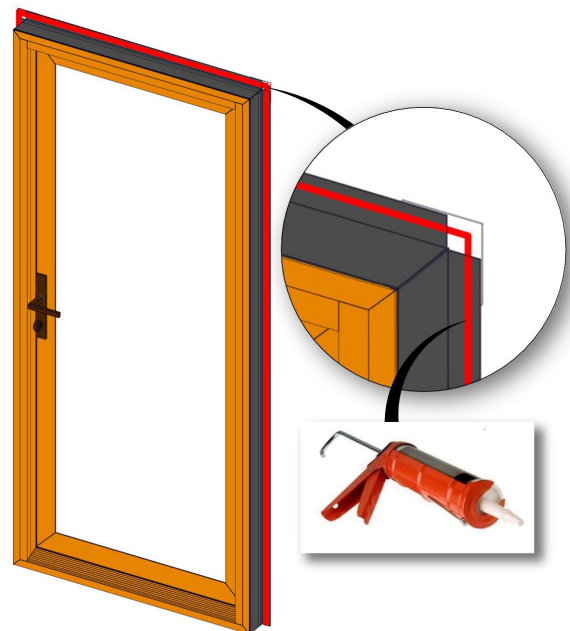

Apply a continuous 3/8" bead of sealant around the perimeter of the interior side of the positioning fin as shown.

11



Install door in rough opening, setting in the bottom of the door first, working in to place behind the mull. Verify squeeze out of sealant along positioning fin. Refer to the appropriate door install guide for anchoring door (IG-070 No positioning fin or IG-071 With Positioning Fin) but do not install the door jamb cover on the mull side yet, or the head cover and sill threshold.

DO NOT nail or fasten through the positioning fin!

12

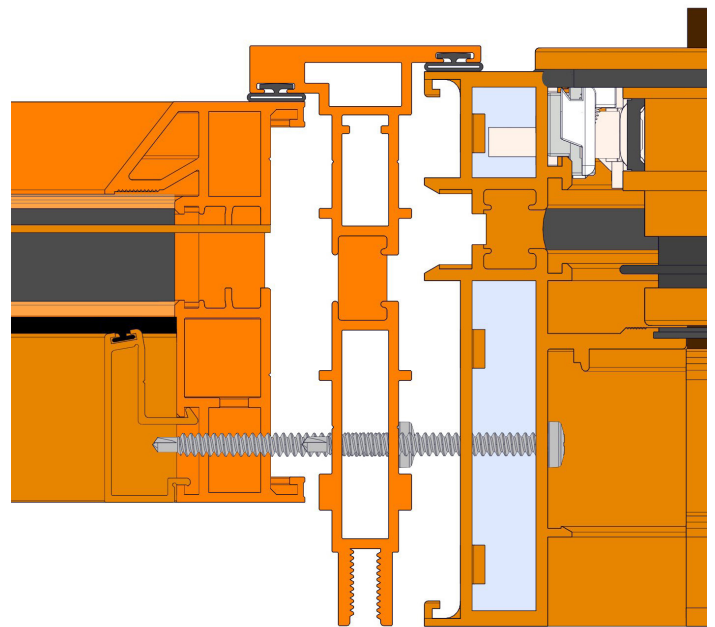

Drill pilot holes through the door jamb into the transition mull. Fasten through the door jamb into the mull, typically with #12 x 2" screws by others, spaced 6" from the top & bottom and 16" centers thereafter. Jamb cover, head cover and sill threshold can now be installed on the door.

Take caution not to drill & screw into the screws previously installed for the mull to window connection.

13

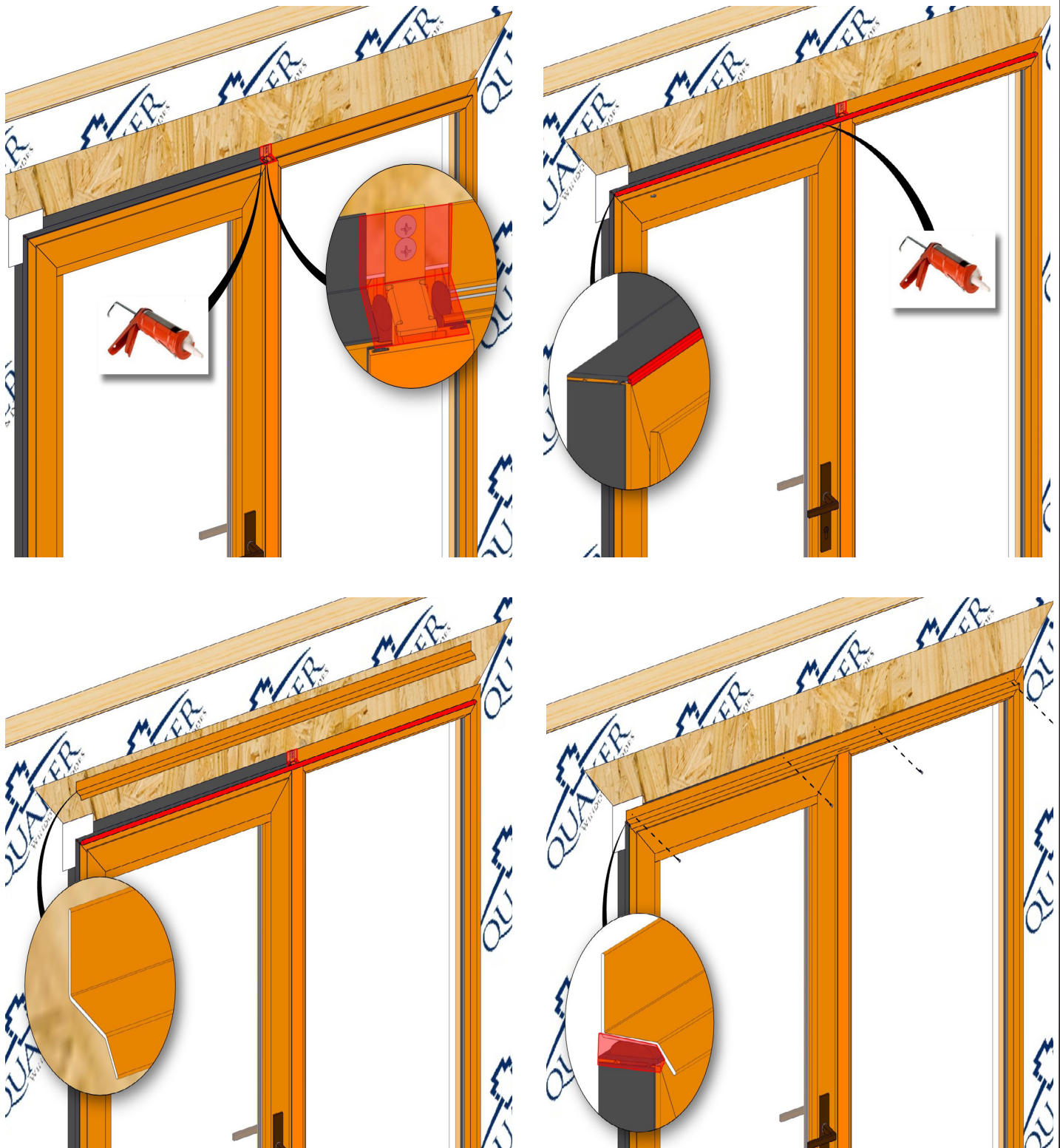

After units and mulls have been installed, leveled, and squared, insert backer rod into gaps between frames at the top of the mull. Apply sealant over the top of the transition mull area to cover gaps between the mull and frame. Apply a continuous bead of sealant across the entire top outer frame edge then set drip cap and fasten in place. Use backer rod and sealant to cover both ends between the drip cap and frames.

Refer to IG-070 (no positioning fin) or IG-071 (with positioning fin) for proper flashing, insulating, and sealing instructions.

14



Finish flashing the exterior of the window per Quaker standard nail fin installation guidelines.

15

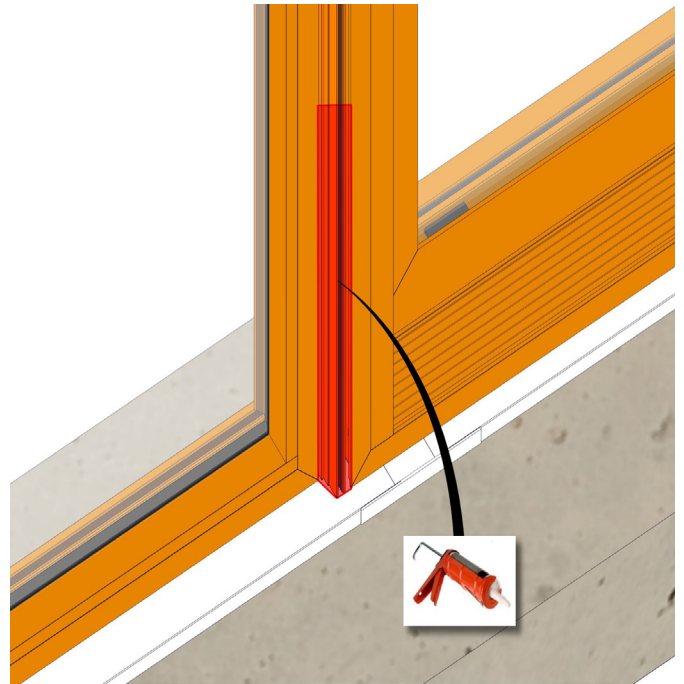

Apply sealant, on the interior side, up the bottom 6" of the center of the transition mull filling the entire area as shown.

16

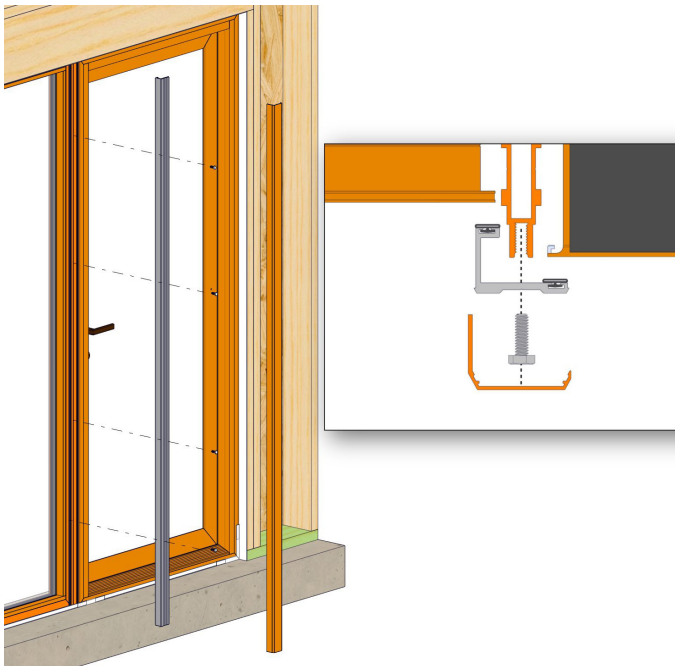

Insert the base plate with the weather-strip flat against the window and door units and install with supplied bolts (MH14 20x3/4) approximately 18" on center. Snap the finish trim cap over the base plate to finish the T-mull.

17



Insulate and seal around the entire perimeter of the window units.

Transition Mulls

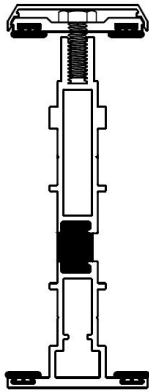

T-MULL

M24487 - T-MULLM23056 - BASE
 M23058 - CAP
 BPN-9159 - W.S. (QTY. 4)
 MH1/4 20X3/4 - BOLTS (18" APROX. O.C.)
 5228 - ANCHOR (QTY. 2)
 MPS-8X1 1/2 - FASTENERS (QTY. 2)

CAN ONLY BE USED WITH TD-TD MULLED UNITS

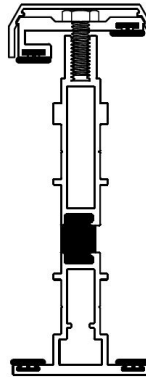

T-MULL

M24487 - T-MULL
 M24485 - BASE
 M24486 - CAP
 BPN-9159 - W.S. (QTY. 4)
 MH1/4 20X3/4 - BOLTS (18" APROX. O.C.)
 5228 - ANCHOR (QTY. 2)
 MPS-8X1 1/2 - FASTENERS (QTY. 2)

CAN ONLY BE USED WITH TD-Cityline MULLED UNITS

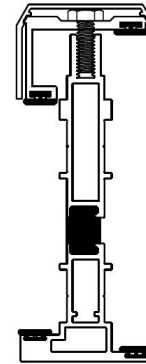

T-MULL

M24482 - T-MULL
 M24480 - BASE
 M24481 - CAP
 BPN-9159 - W.S. (QTY. 4)
 MH1/4 20X3/4 - BOLTS (18" APROX. O.C.)
 5228 - ANCHOR (QTY. 2)
 MPS-8X1 1/2 - FASTENERS (QTY. 2)

CAN ONLY BE USED WITH TD-Edgeline MULLED UNITS

This transition mull uses a different L-angle than those above and the units are set hard against the mull.

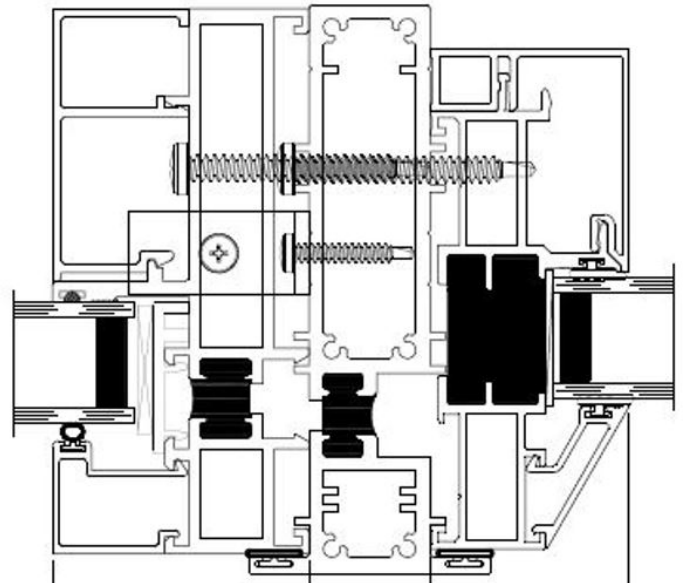
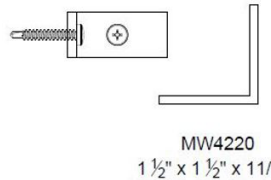
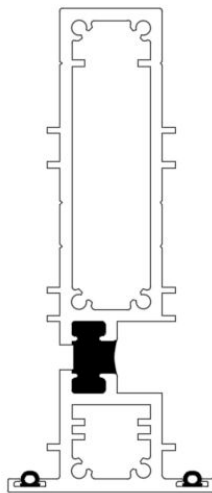

TRANSITION MULL

M57588 - T-MULL
 PN-2930 - W.S. (QTY. 4)
 MH1/4 20X3/4 - BOLTS (18" APROX. O.C.)
 MW4220 X 3/4 - L-ANGLE (QTY. 2)
 MPS-8X1 1/2 - FASTENERS (QTY. 4)



Installation Guidelines

M-Series Terrace Door

Transition T-Mull Installation

If this set of instructions doesn't match your installation method or wall conditions please check our website listed below for other options, or call the office.

Scan here for a digital version of these guidelines in English



Or go to: <https://www.quakercommercialwindows.com/resources/installation-instructions-english/>

Scan here for a digital version of these guidelines in Spanish



Or go to: <https://www.quakercommercialwindows.com/installation-instructions-spanish/>

