

CityLine/CityVu EdgeLine/EdgeVu M-Series (M2055) MultiSlide/Bi-Parting Door Installation Guide

IG-083 REV. 04/24 1.6

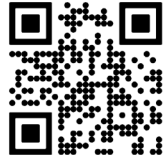

CityLine CityVu

Scan Here for a Digital Version of the
Installation Guides in English.

Quartz Luxury Windows & Doors:
www.quartzluxurywindows.com



EdgeLine EdgeVu

Scan Here for a Digital Version of the
Installation Guides in English.

Quaker Residential Windows & Doors:
www.quakerresidentialwindows.com

Not Available for Commercial.



Para ver las instrucciones en Español, escanea aquí.

If this set of instructions does not match your installation method or the wall conditions of the job site, please check our website listed below for other options, or call Quaker Customer Service for additional information.



Quaker Window Products
504 U.S. Hwy 63 South
Freeburg, MO 65035
(800) 347-0438
www.quakerwindows.com



CityLine/CityVu EdgeLine/EdgeVu M-Series (M2055) MultiSlide/Bi-Parting Door Installation Guide

Read these instructions completely before starting any installation. Failure to install and maintain our product according to these instructions may void any product warranty. These are generic instructions intended to cover most common situations, which may not be appropriate for all installations due to building design, construction materials, or methods used and/or building or site conditions. Please visit our website at www.quakerwindows.com or call 1-800-347-0438 for additional information. Inspect all units for any damage or defects prior to installation.

Tools required by installer:

Safety Glasses		Utility Knife	
Drill/Driver		Caulk Gun	
Level		Tape Measure	
Hammer		J-Roller	
Putty Knife		Staple Gun	
Phillips #2 Screwdriver		Metal Cutting Saw	
Torx #20 Bits			

Materials required by installer:

Foam Backer Rod		Minimally Expanding Spray Foam	
Shims (waterproof)		C920 Silicone	
Flashing Tape (Self-Ahering)		Water Resistant Barrier/House Wrap (WRB)	
Fasteners		IPA Alcohol	

⚠ WARNING

Tools

- Follow manufacturer's instructions for safe operation of tools, and ladders/scaffolding. Always wear safety glasses. Failure to do so could result in injury, product or property damage.

Handling

- Do not store units outside, or in a hot environment. Doing so could result in product damage.
- Do not carry flat.** Doing so could result in product damage, injury, or property damage.
- Stack units as straight as possible to avoid bowing. **Do not lay flat!**

Glass

- If broken, glass can fragment causing injury. All Quaker products are available with safety glass. In many areas, local building codes require safety glass in certain locations and/or applications. Quaker door products are provided with safety glass per industry standards. Consult your local building codes for more definitive information.

Fastening

- Metal fasteners and components could corrode when used with preservative-treated lumber. Use approved fasteners and components to fasten window or door. Failure to do so could cause a failure resulting in injury, product or property damage.
- Fastener must attach to a structural framing member with 1 1/2" minimum fastener embedment, or minimum 3 full threads with a minimum 5/16" head as products were tested with.
- Quaker does not supply anchorage/fastener calculations, and is not responsible for determining structural adequacy of the anchorage and fasteners used to install our products, or the openings into which they are installed.**
- Do not** over drive screws or nails. Doing so could result in product damage.

Notice

- The suggested overhang of the structure should match the height of the unit being installed.

⚠ CAUTION**Installation**

- Maintain a minimum of 1/4" between the window or door frame and exterior finish materials. Failure to do so could result in product or property damage.
- Nailing flanges and drip caps (integral or applied) **do not** take the place of window and door flashing. All windows and doors must be properly flashed and sealed with material compatible sealant for protection against water and air infiltration around the entire perimeter. Failure to do so could result in product or property damage.
- Place shims around perimeter as required. Door must be properly shimmed. Failure to do so could affect operation and product performance and could result in product damage.
- Live or dead loads transferred into our product can affect functionality, damage frame joinery or cause glass failures. Dead loads such as upper levels, roof, etc. Should be constructed before window or door is installed.
- Loads shall be designed to withstand the most critical effects of load factors and load combinations as required by the building code. (Loads are including but not limited to Live, Dead, Collateral, Auxiliary, Thermally induced, Seismic, etc.)
- Maximum vertical deflection of the header under all Load combination should not exceed 1/8".
- **Do not** drill through or into door sill to install alarm wires.

Sealing

- Follow instructions of foam, sealant, and flashing manufacturers regarding safety, material application, compatibility, and periodic maintenance for continued weather resistance of their products. Failure to do so could result in product or property damage. **DO NOT** overfill between the frame and opening.
- Minimally expanding foam insulation must be compliant with AAMA 812-19.
- Quaker requires 100% silicone (ASTM C920 compliant) neutral cure only sealant. Always clean all areas where sealant will be applied. Failure to do so could result in product or property damage.
- Flashing tape must meet ASTM-D779 performance requirements.

Joining

- Do not join any window or door to any window or door not designed for joining. Joined windows and doors must be individually supported in the opening. Failure to do so could affect operation and product performance and could result in product or property damage.

Cleaning

- Acid solutions used for cleaning will damage glass, fasteners, hardware, and metal flashing. Protect these products and follow cleaning products manufacturers instructions. If acid contacts the window or door, wash all surfaces immediately with clean water.
- **Do not** use razor blades to clean glass surface. Glass damage could result.
- Clean glass using liquid glass cleaner.
- Clean frame, sash, panels, and insect screens using mild detergent and warm water with a soft cloth or brush.

IMPORTANT

- Buildings constructed prior to 1978 could contain lead paint which could be disturbed during window or door replacement. For more information on proper management of lead paint, go to: www.epa.gov/lead
- Care must be taken to properly recycle or dispose of old materials. Any recyclable materials should be separated from non-recyclable or hazardous materials. Please consult with local or state authorities regarding proper disposal of non-recyclable or hazardous materials

⚠ WARNING: This product can expose you to chemicals including titanium dioxide or methanol, which are known to the State of California to cause cancer and birth defects or other reproductive harm. For more information go to www.P65Warnings.ca.gov.

⚠ WARNING: Drilling, sawing, sanding or machining wood products can expose you to wood dust, a substance known to the State of California to cause cancer. Avoid inhaling wood dust or use a dust mask or other safeguards for personal protection. For more information go to www.P65Warnings.ca.gov/wood.

1











Verify Header Support

Ensure the roof over the door system is full supported. Take into account the weight of any materials around the door system, because this may cause deflection. No more than 1/8" deflection is allowed for install. Confirm that all materials and fasteners are adequate for the load requirements.

If you have any questions please feel free to call us at Quaker Windows.

Phone : 1 (800) 347 – 0438.

2

QUAKER						STANDARD OPERATING PROCEDURE		
TITLE						DATE	ASSOCIATE	
Packing List For 3 Panel Door						3/20/2023	J Loehner	
SOP#	RMS.V5	VERSION	1.0	DEPT	551	SERIE S	RMS V5 Packing List	
<input type="checkbox"/>	(M25275)	-----Sill Pan For Opening-----					1	
<i>* If Door calls out over 240" need to Splice Cut in Half. Then would be 2 Pieces. Under 240" only 1 piece.</i>								
<input type="checkbox"/>	(FE_25-7X10-35-DT)	-----Frame Corner Key-----					4	
<input type="checkbox"/>	(FE_FAST2)	-----Corner Key Frame Screw-----					8	
<i>***Add 4 if Unit Is Spliced.</i>								
<input type="checkbox"/>	(FE_26X10_200_TC)	-----Frame Splice Key-----					2	
<i>***These should only be sent with Spliced Door Systems</i>								
<input type="checkbox"/>	(M24705)	-----Frame Jamb Covers-----					4	
<input type="checkbox"/>	(M24705)	-----Long Frame Head Covers-----					1	
<input type="checkbox"/>	(M24705)	-----Short Frame Head Cover-----					1	
<input type="checkbox"/>	(M25278)	----- Sill Covers-----					2	
<i>* Make sure 3D Part # TBD is on End of Sill Cover</i>								
<i>* Supply Weatherstripping Part # TBD</i>								
<input type="checkbox"/>	(9309K86)	-----Panel Bumper-----					6	
<input type="checkbox"/>	(ST150-16)	-----SS Roller Tracker Cover-----					3	
<i>* ST150-20 is used if Sill is longer than 192"</i>								
<i>* If spliced sill over 240" Double the amount needed</i>								

Before installing your door, unpack all parts and place near the opening. Make sure you have all parts according to the packing slip and check for damaged parts.

3

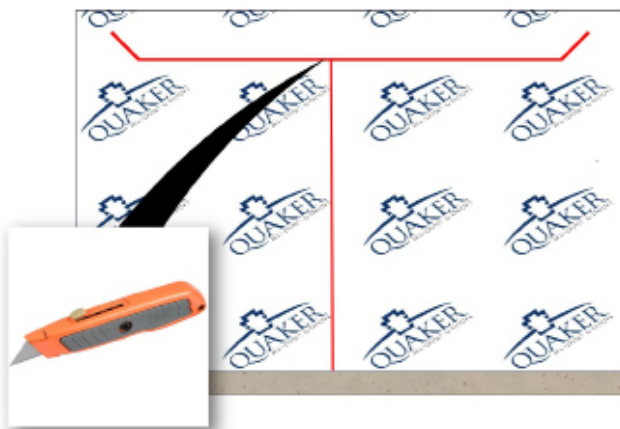

Apply the house wrap according to the manufacturer's instructions and cut T-pattern opening as shown above. Cut top flap angles at 45 degrees and 1" longer than the width of flashing tape being used.

4

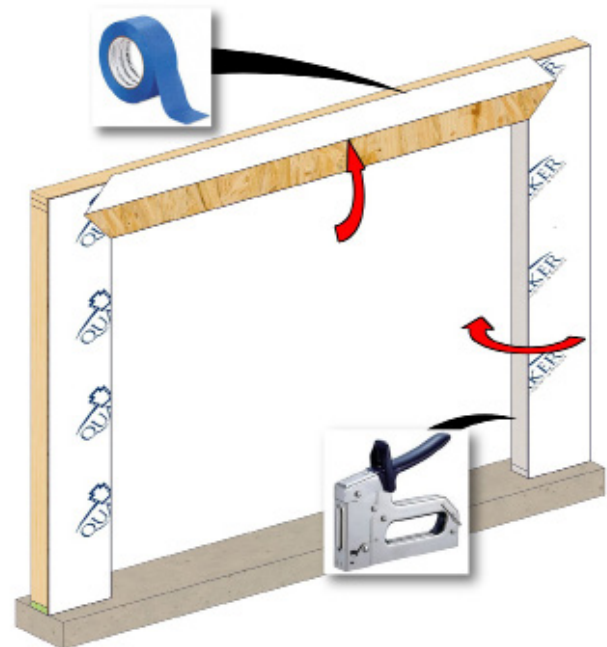

Fold the house wrap around the jambs to the interior and staple it to the interior framing. Fold the house wrap flap up and temporarily tape it in place.

5

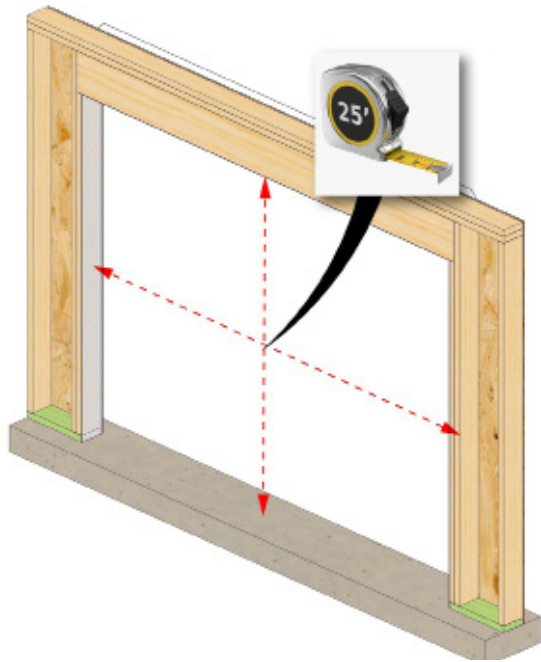

Measure and verify the rough opening is sized correctly. The rough opening should be 3/4" wider and 1/2" taller than the unit. Allow additional space for flashing thickness, installation clips, joining components, and their fasteners.

6

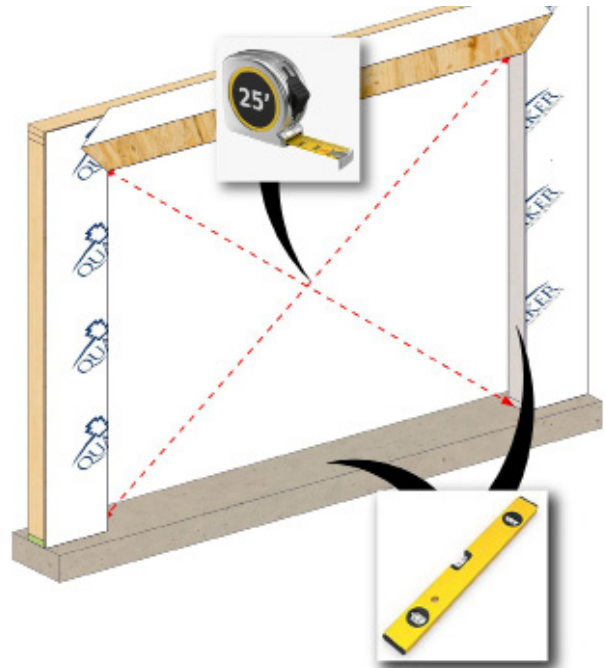

Check that the opening is square. The diagonal measurements need to be within 1/8" of each other. Verify the rough opening is plumb and level.

! The sill plate beneath the unit must be level for proper unit operation.

7

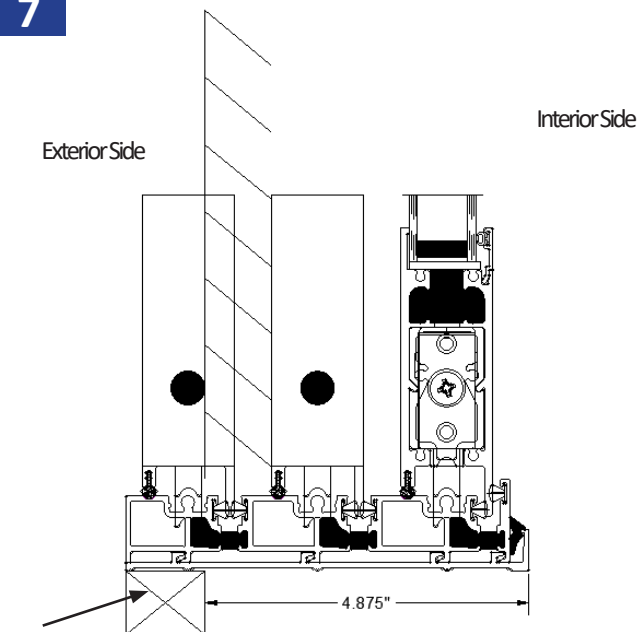

The sill pan will set 4 7/8" in from the exterior face of wall framing, where the frame positioning fin sits.

! The unit must be supported the full width and depth of the sill.

(Note: For Nail fin installation only.)

8

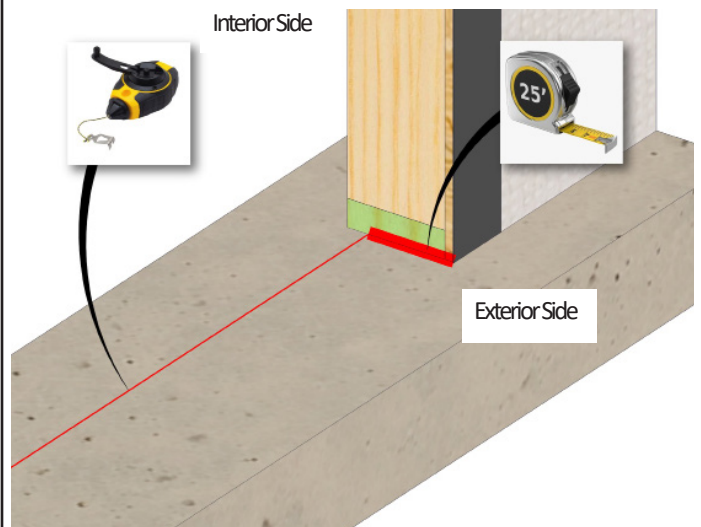

Measure and set a chalk line on the sub floor 4 7/8" in from the exterior wall face. Dry fit the provided sill pan system with the rear upturned leg on this line.

The sill condition must be level.

9

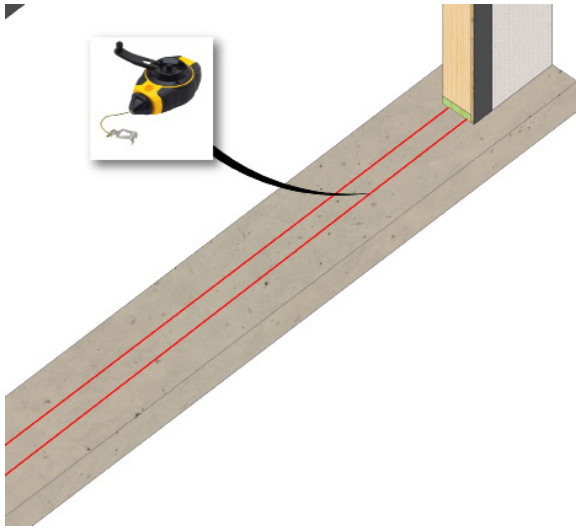

Snap another chalk line, width of sill pan from previous chalk line. This is where the sill pan will sit.

10

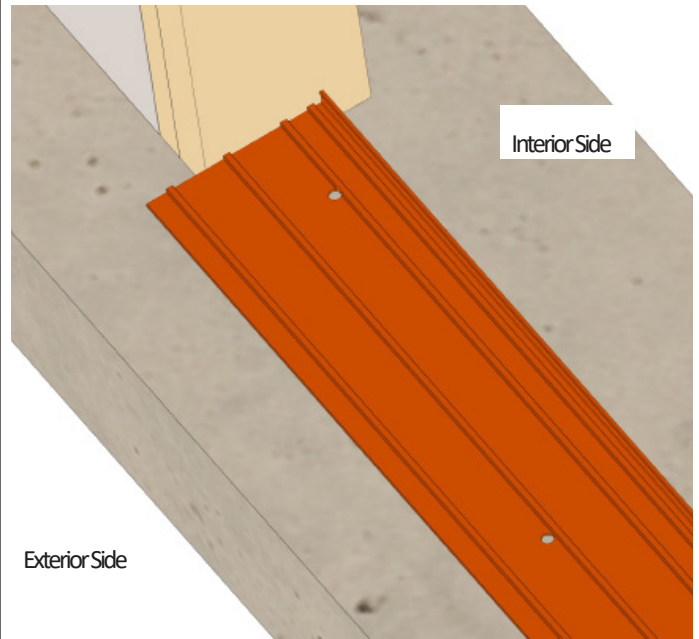

Rough fit the sill pan in place to ensure of proper fitment.

SILL MUST BE LEVEL! Quaker first recommends **self leveling concrete**, if not available shim 1' or less, on center.

FRAME ASSEMBLY

Assemble the frame to make sure sizing is correct.

Multi Tracks - See below - Skip to the step that matches the door which you are wanting to install.

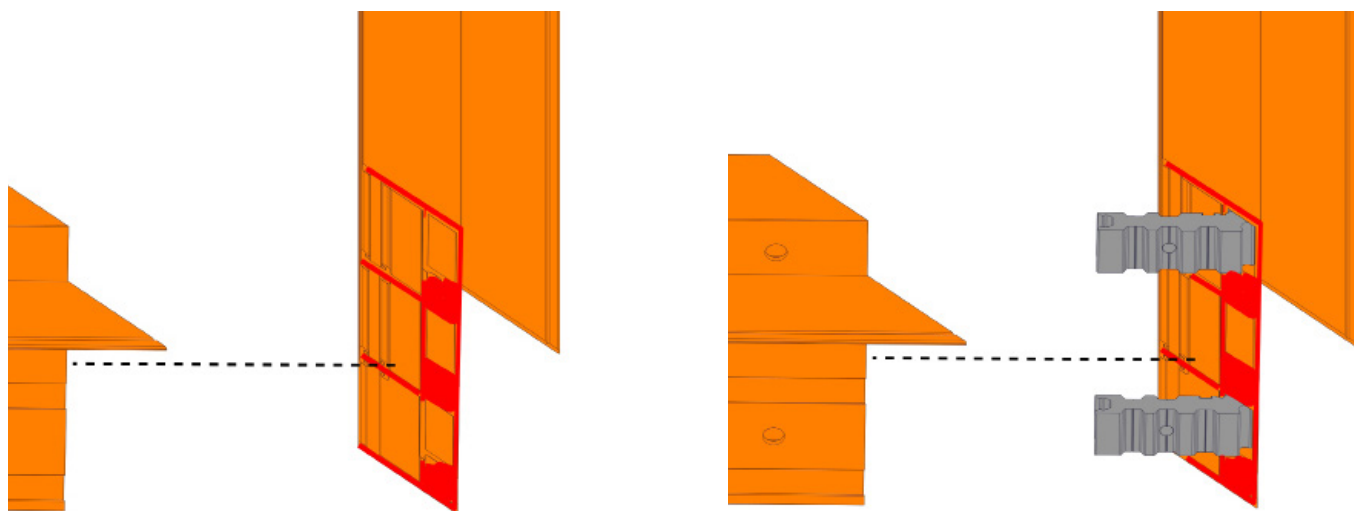
11

Place a gasket (Part #: QWP-MMSD-V4FG1(B/W)) on each face profile of the frame header. Place 2 of the corner keys (Part #: FE_25-7x10-35-DT) in both ends of the frame header and join to both frame jambs. Trim weather strip flush to both ends.

12

4 Tracks

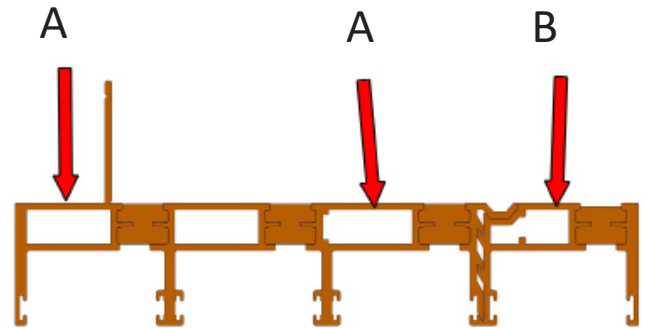
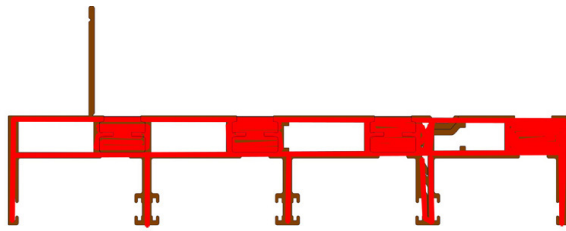

Place a gasket (Part #: QWP-MMSD-V5FG4(B/W)) on each face profile of the frame header. Place 2 of the corner keys (Part #: FE_25-7x10-35-DT) in both ends of the frame header by arrow (A) and place corner key (Part #: M25762-PCS) by arrow (B). Then join to both frame jambs to head. Trim weather strip flush to both ends.

12

5 Tracks

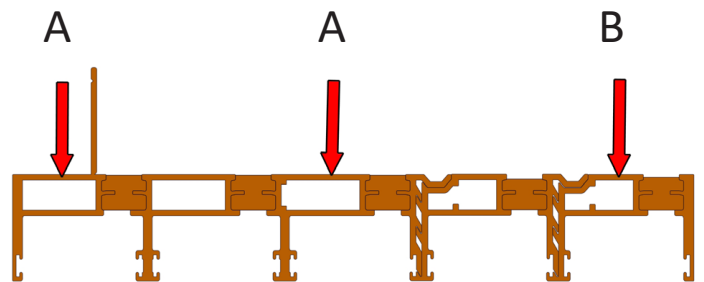
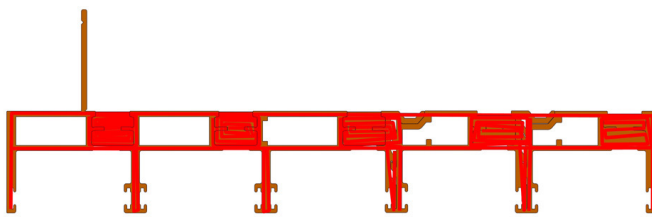

Place a gasket (Part #: QWP-MMSD-V5FG5(B/W)) on each face profile of the frame header. Place 2 of the corner keys (Part #: FE_25-7x10-35-DT) in both ends of the frame header by arrow (A) and place corner key (Part #: M25762-PCS) by arrow (B). Then join to both frame jambs to head. Trim weather strip flush to both ends.

12

6 Tracks

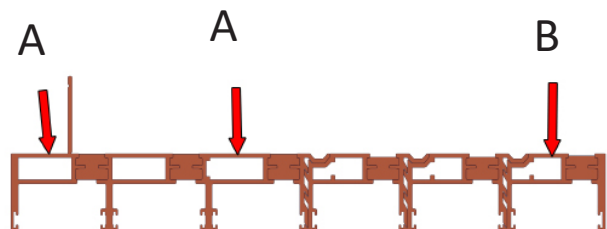
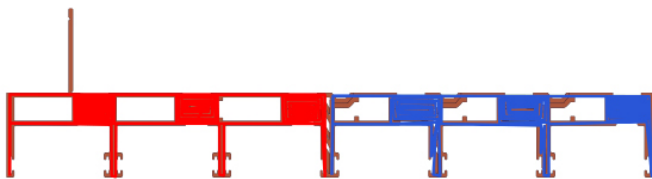

Place gasket (Part #: QWP-MMSD-V4FG1(B/W)) (RED) on the first three tracks, and then place gasket (Part #: QWP-MMSD-V5FG6(B/W)) (BLUE) on the other three tracks. This will go on each face profile of the frame header. Place 2 of the corner keys (Part #: FE_25-7x10-35-DT) in both ends of the frame header by arrow (A) and place corner key (Part #: M25762-PCS) by arrow (B). Then join to both frame jambs to head. Trim weather strip flush to both ends.

13

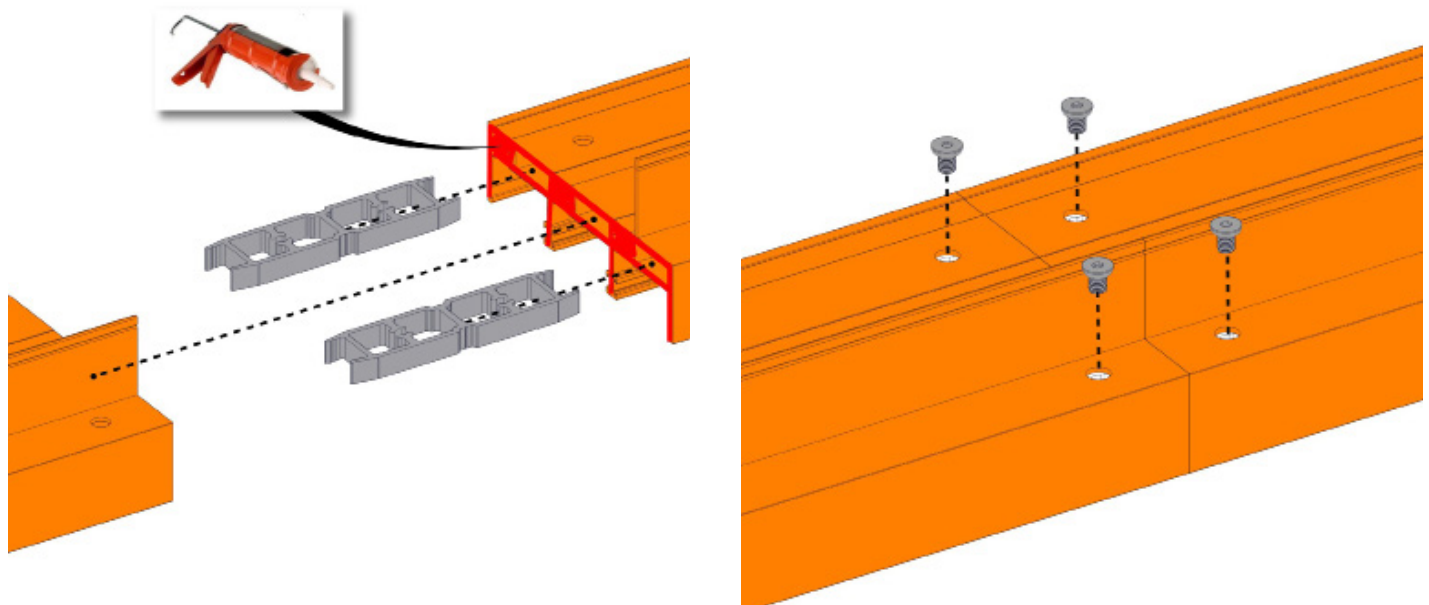

For Two-piece Headers Needing a Splice:

Place a gasket on the face profile of the frame header. Put two splice keys in the first header as shown & screw those in place with 2 corner key screws. Then slide the other header over the keys and secure in place with 2 more corner key screws.

3 Tracks

Gaskets -
QWP-MMSD-V4FG2(B/W)
Corner keys-
FE_26X10_200_TC

4 Tracks

Gaskets -
QWP-MMSD-V5FG7(B/W)
Corner Keys -
FE_26X10_200_TC and M25762-PCS

5 Tracks

Gaskets -
QWP-MMSD-V5FG8(B/W)
Corner Keys -
FE_26X10_200_TC and M25762-PCS

6 Tracks

Gaskets -
QWP-MMSD-V4FG2(B/W) and QWP-MMSD-V5FG9(B/W)
Corner Keys -
FE_26X10_200_TC and M25762-PCS

14

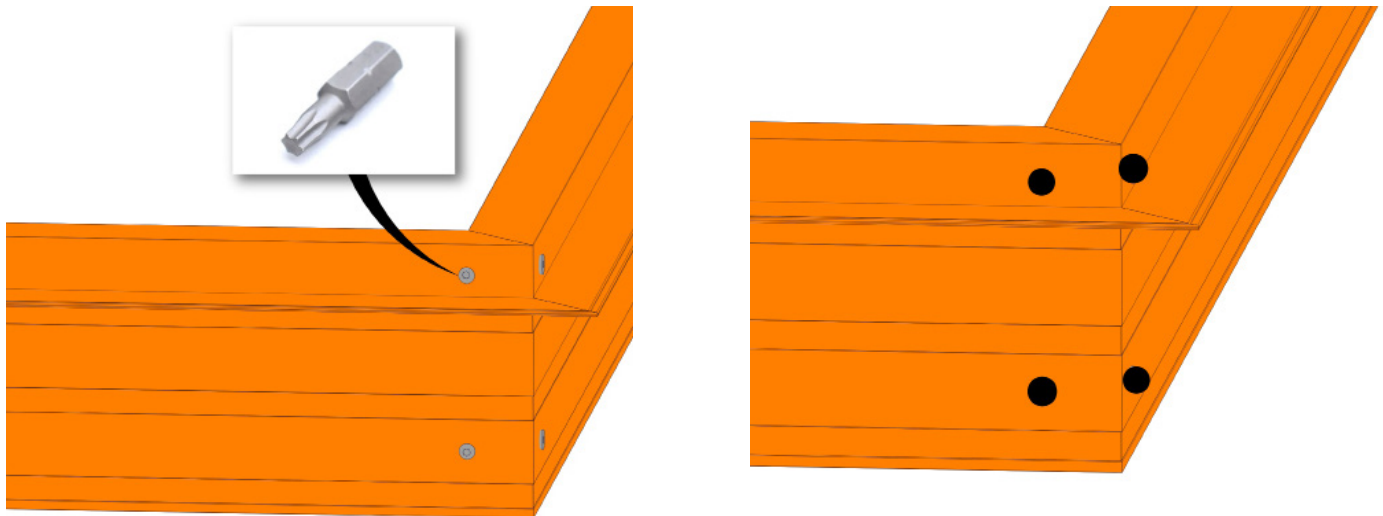

Start screws (Part #: FE FAST2) into the keys at each corner.
Then tighten.
Cover screws with silicone.

15

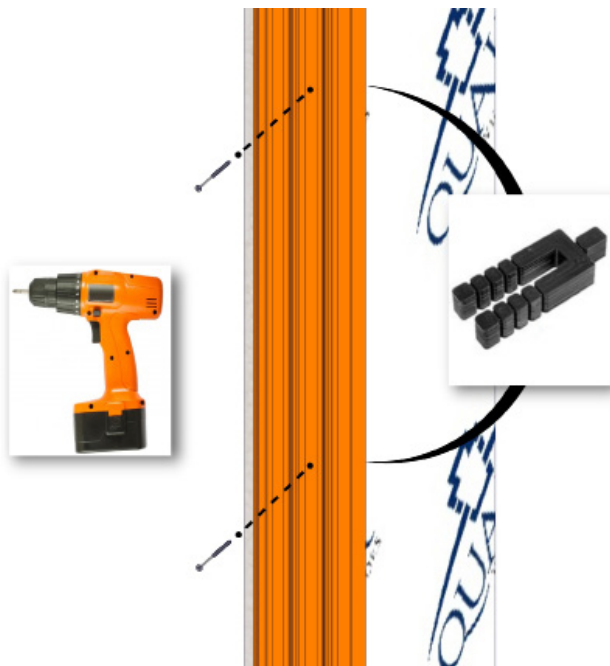

Drill holes through the center track of the header & jambs,
typically 6" from ends and 24" on center.
(Drill bit size is based off the screw being used.)

SILL PAN INSTALL

For the different track configurations the sills and sill pan will install the exact same way, the only difference between them will be the widths of them both.

16

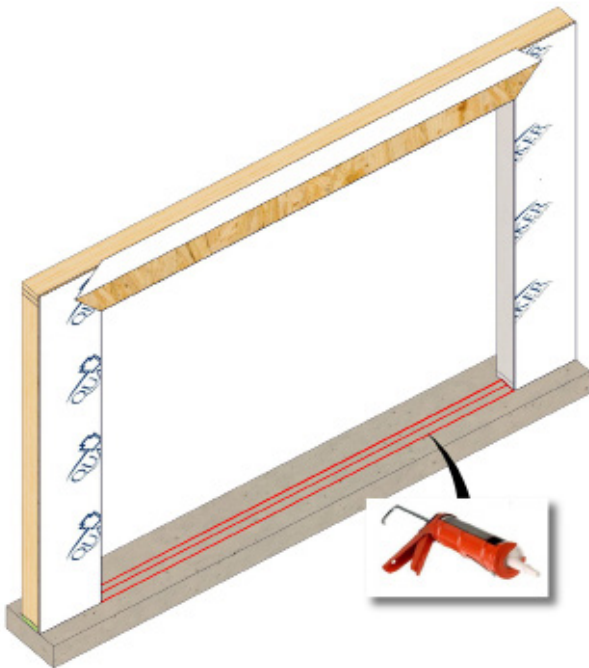

Apply three 3/8" continuous beads of sealant across the entire width of the rough opening sill where the sill pan will set. Apply two 3/8" continuous beads of sealant the width of the pan, 1/2" from each side of opening as shown above.

17

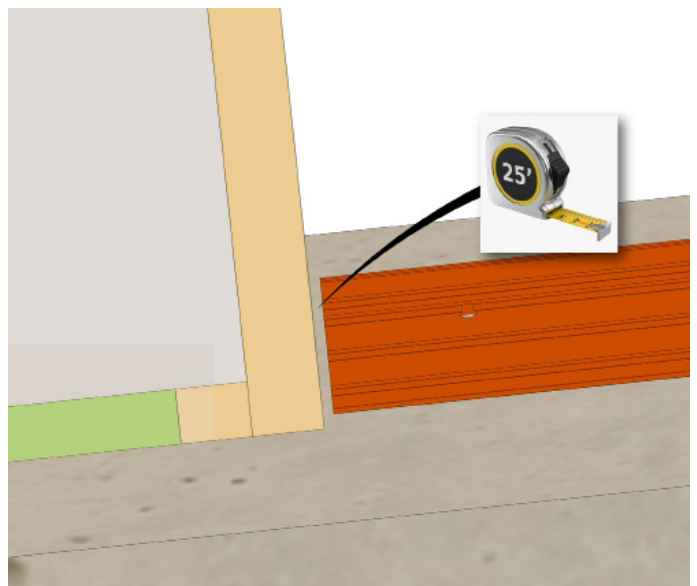

Allow a 1/4" gap between the rough opening and the sill pan(s).

Note: if two sill pans are provided leave a 1/4" gap on each end and but the sill pans together tight in the middle.

18

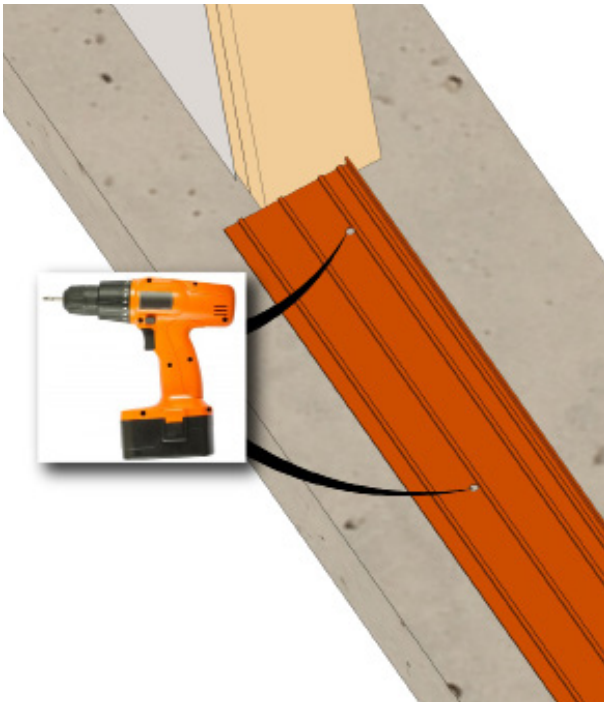

Locate second and third leg and drill holes directly behind them. Drill holes through the sill pan, 3" from each end and then 14" on center for the length of the pan, alternating between the 2 tracks.
(Drill bit size is based off screw size)

19

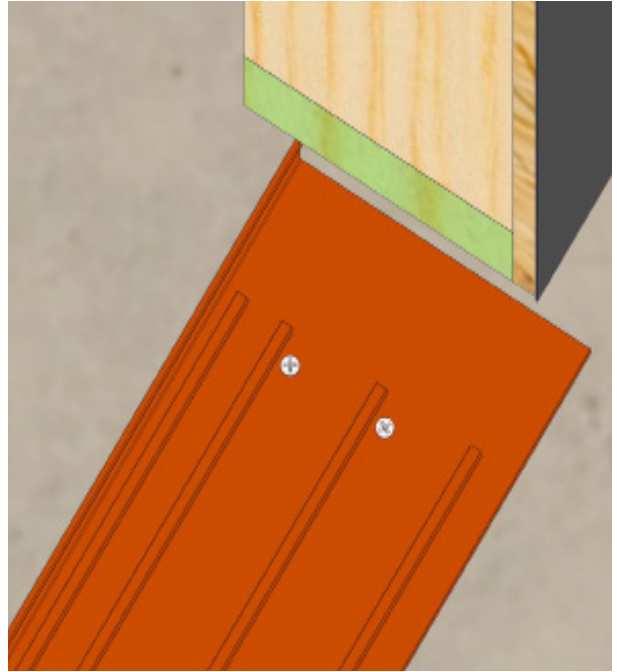

Using a screw with head shorter (less than .150"), screw down the sill pan.

20

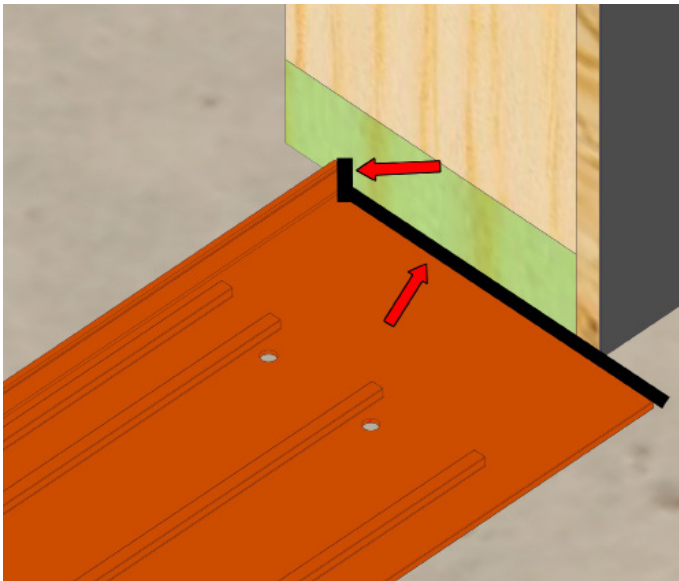

Set the sill pan in place along the wall and upturned leg apply silicone. Be sure to tool in the sealant.
If spliced run a bead of silicone exactly like this on the splice.

21

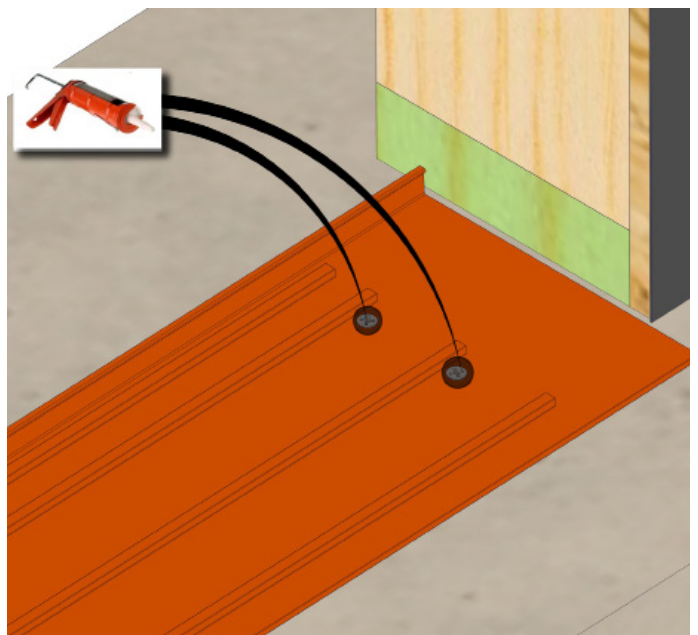

Silicone over all screws and tool in.

FRAME INSTALL

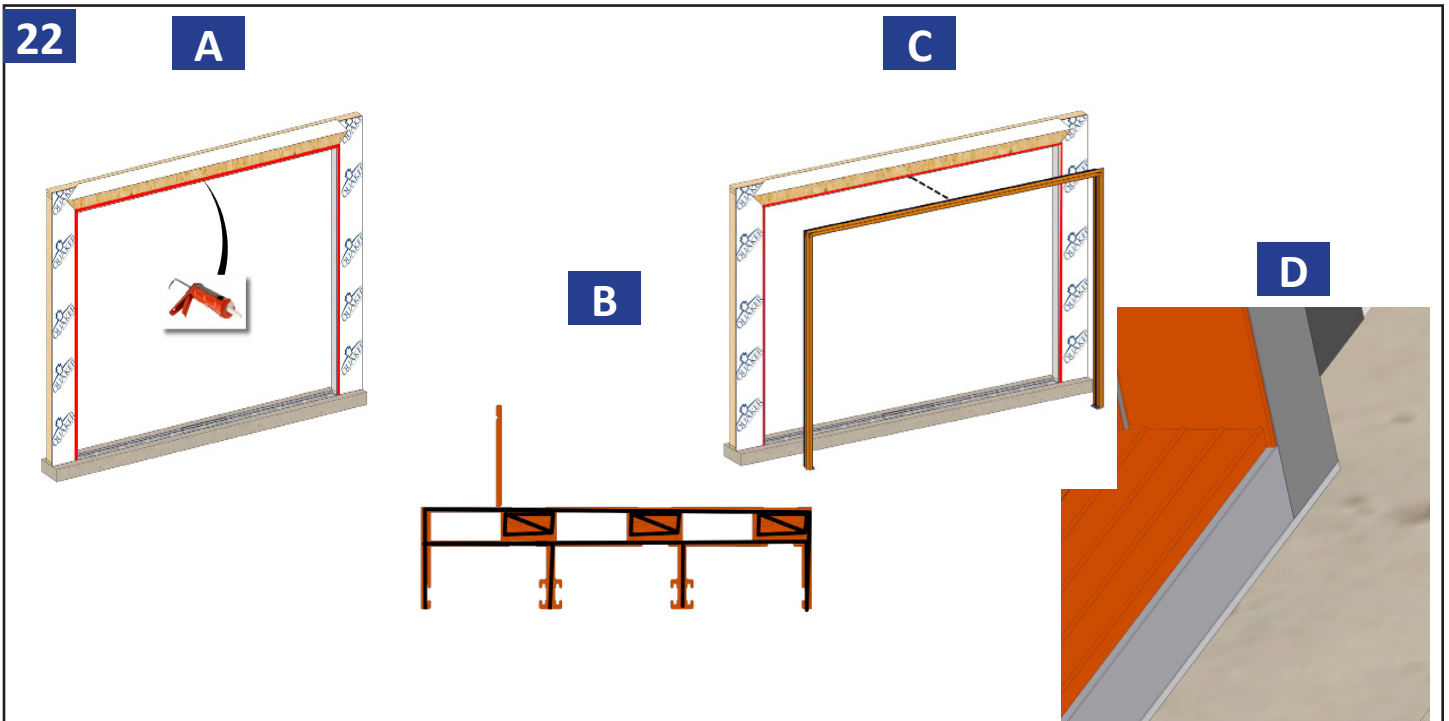

FOR NAIL FIN INSTALL ONLY!

(A) Apply a continuous 3/8" bead of sealant around the perimeter of the opening as shown, (B) also trace the bottom of the frame jambs with sealant. (C) Install the frame by sliding in the rough opening with the fin to the exterior side. Set frame onto the sill pan, make the exterior face of the sill pan, (D) flush with the exterior face of the frame.

23

A

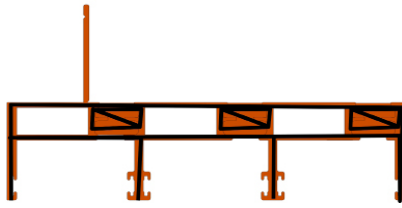

B

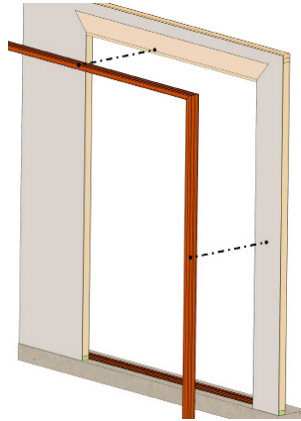

C

**FOR NO NAIL FIN INSTALL ONLY!**

(A) Trace the bottom of the frame jambs with sealant. (B) From the exterior, install the frame by sliding in the rough opening. (C) Set frame onto the sill pan, make the exterior face of the sill pan, flush with the exterior face of the frame.

24

**NAIL FIN ONLY!**

Temporarily secure the frame in the opening at the head corner(s) by tacking a fastener through a slotted hole in the nail fin.

25

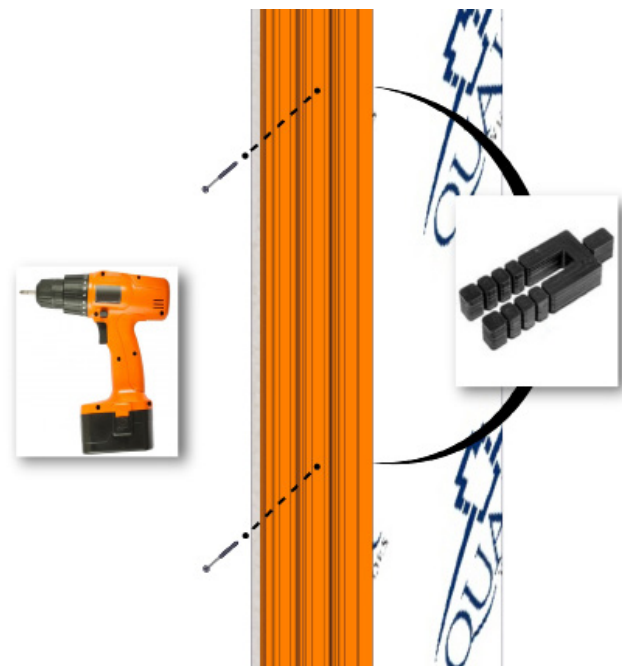

Temporarily set screw just deep enough to hold the frame in place. The screws through the center track of the header & jambs, typically 6" from ends and 24" on center for fasteners.

26

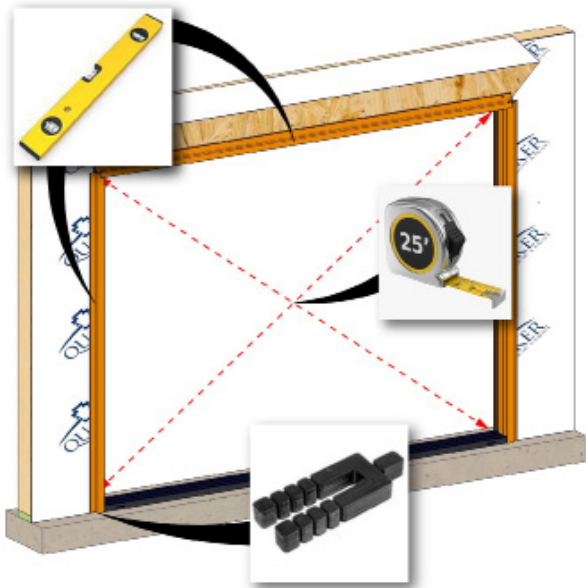

Square, level, and plumb the frame. Adjust shims as needed until diagonal measurements are within 1/8". Shim behind the header and jambs as necessary.

27

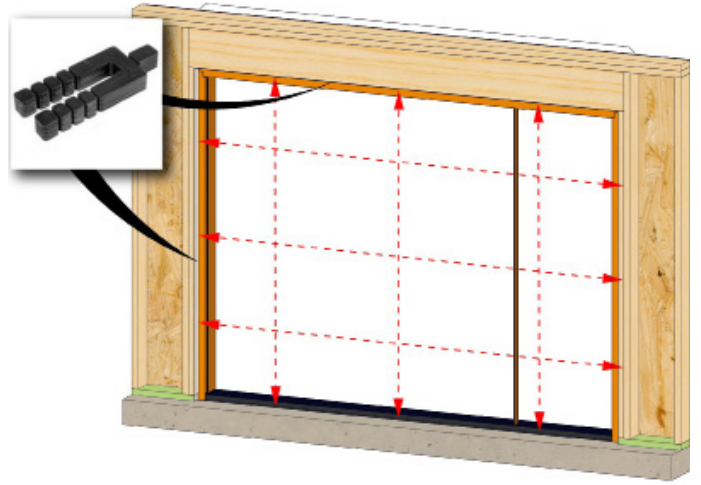

Check that the door frame is not bowed at jambs or head, a string line may be required. Adjust shims as needed but verify measurements are within 1/16".

28

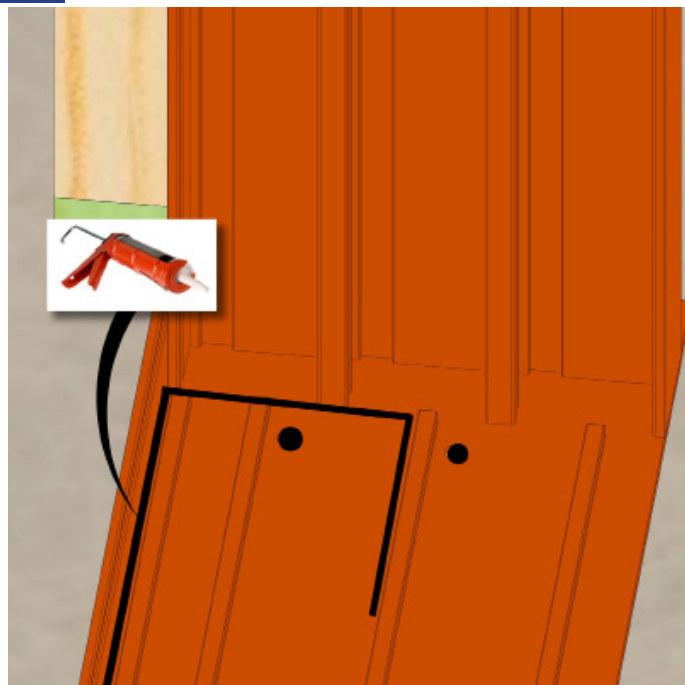

Run a bead of silicone along the wall, up the leg of the sill pan, and along the interior most leg the length of the sill pan.

Note: This will be the space between the lip of the sill pan and the first leg, as shown above.

29

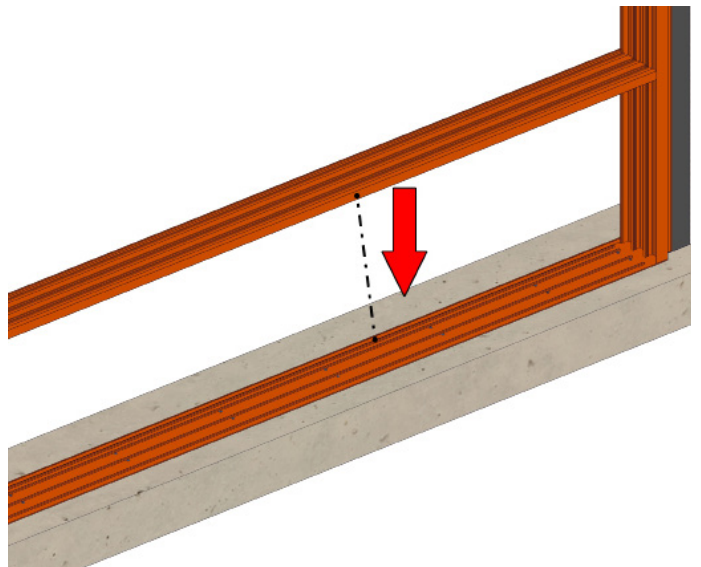

Make sure all foreign material is removed from sill and sill pan(s). Set the sill(s) in place.

Note: if two sill pans are provided but them tight in the middle.

30

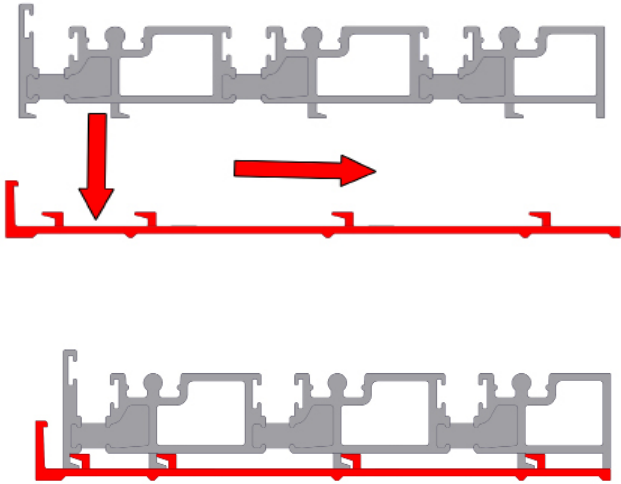

Push the sill down and then toward the exterior to lock in the sill to the sill pan.

31

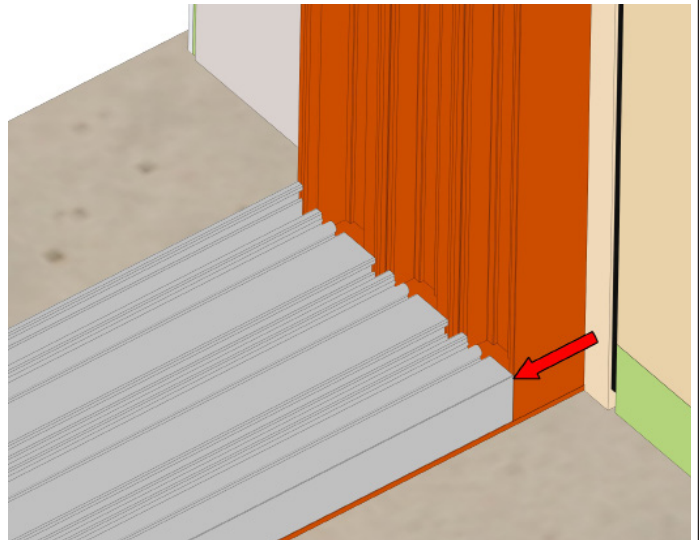

Shim jamb frame to the sill. No more than a 1/16" gap.

32

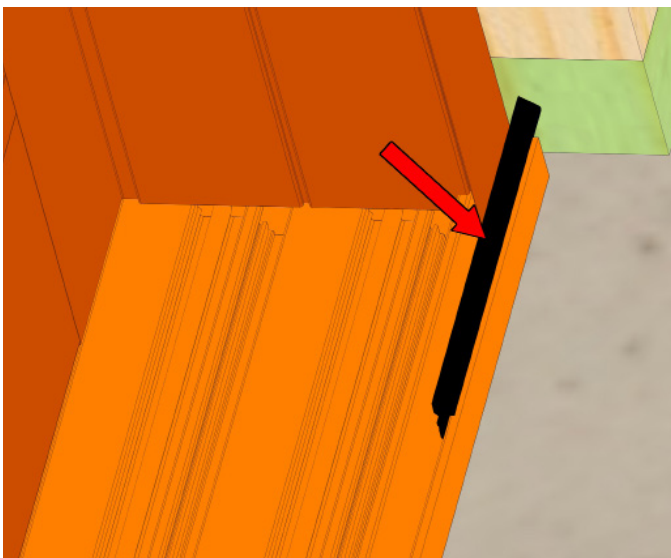

Cut a small piece of wedge gasket and place it on the other end of the sill.

33

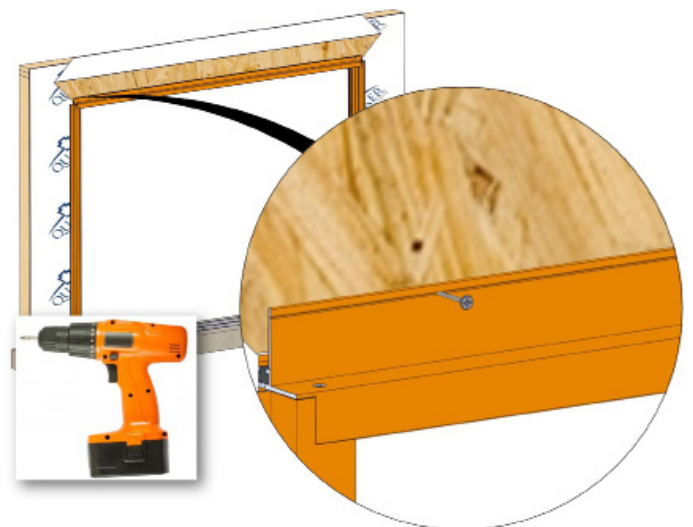

NAIL FIN ONLY!
Fully fasten the screws down now to hold the frame in place.

34

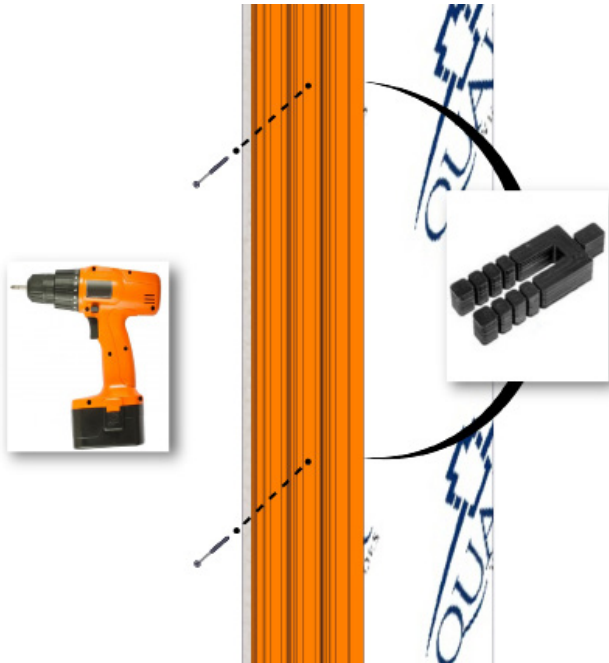

Fully fasten the screws down now to hold the frame in place. The holes through the center track of the header & jambs, typically 6" from ends and 24" on center for fasteners.

35

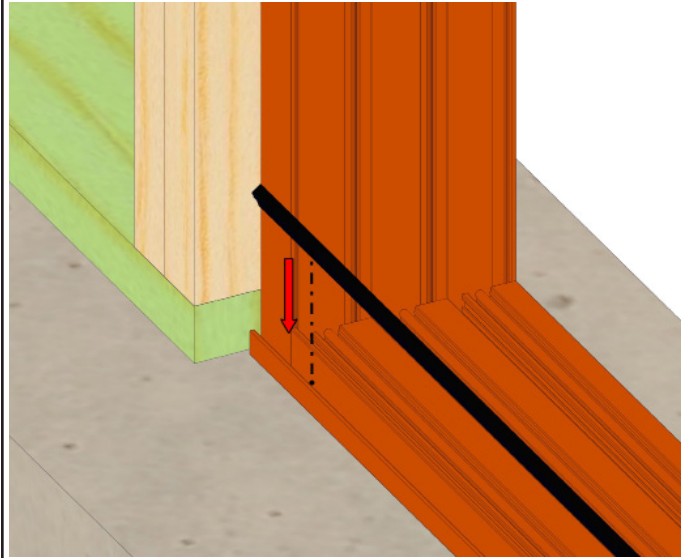

Locate the interior side of the sill. Push the sill down and towards the exterior to lock in place. Take the wedge gasket (Part #: 4874-02-00) and press in place.
Note: This will run the whole length of the sill pan(s).

PANEL INSTALL

For panel install the process is the same no matter the amount of panels. You always start with the active (interior most) panel and end with the fixed (exterior most) panel.

36

Glazing Beads to Interior

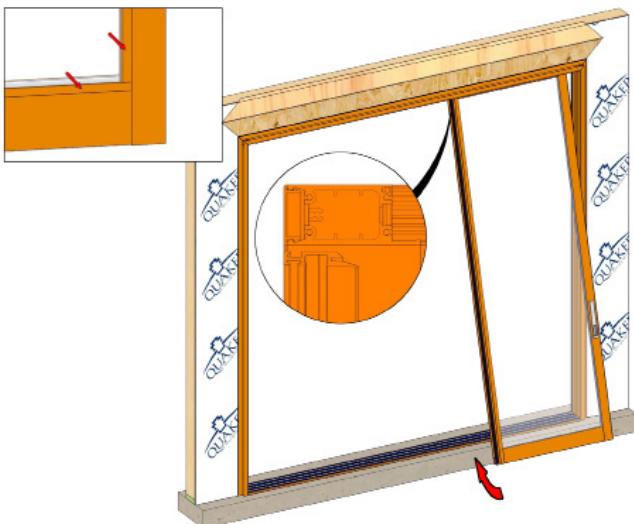

Active or Inactive Panel Shown

From the exterior, install the active panel with the handle, by tilting the top into the inner most head track and setting the bottom of the panel in the inner most groove in the sill track.

- *Note orientation of interlock rails when choosing panels.
- *Note glazing beads are to the interior side.

37

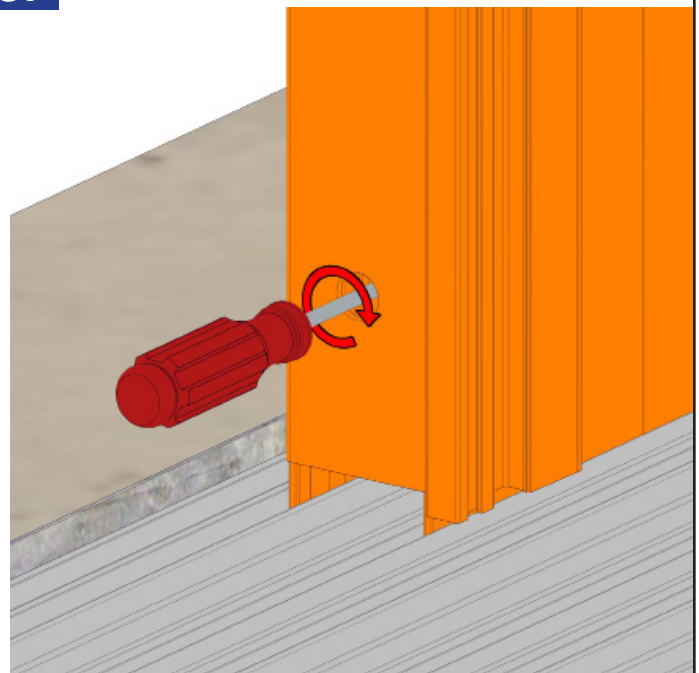

Use a #2 phillips screwdriver to engage the roller adjustment on both sides of a panel. Turn clockwise to raise the panel and provide smooth rolling. If possible, lift the panels slightly when adjusting to take pressure off the rollers. Roll panel back and forth 2-3 times to verify roller height is set. Repeat this step for each panel installed.

38

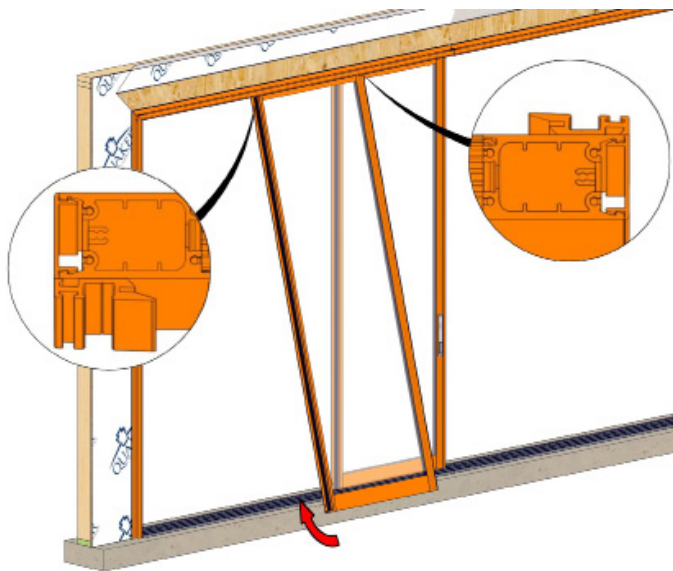

Center Panel Left Shown

For the center panel on the left placing it in the center tracks. Make sure the panels are overlapped when installing so the interlocks will engage properly.

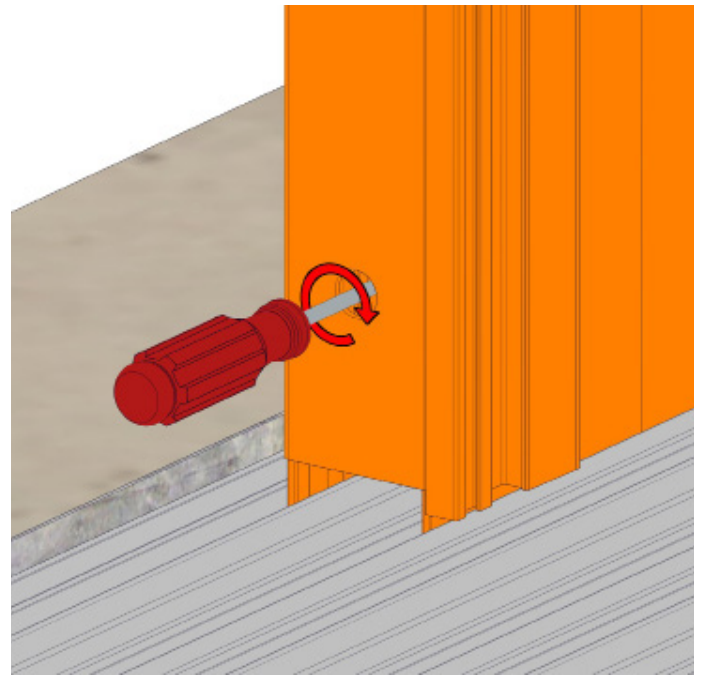

Use a #2 phillips screwdriver to engage the roller adjustment on both sides of a panel. Turn clockwise to raise the panel and provide smooth rolling. If possible, lift the panels slightly when adjusting to take pressure off the rollers. Roll panel back and forth 2-3 times to verify roller height is set. Repeat this step for each panel installed.

39

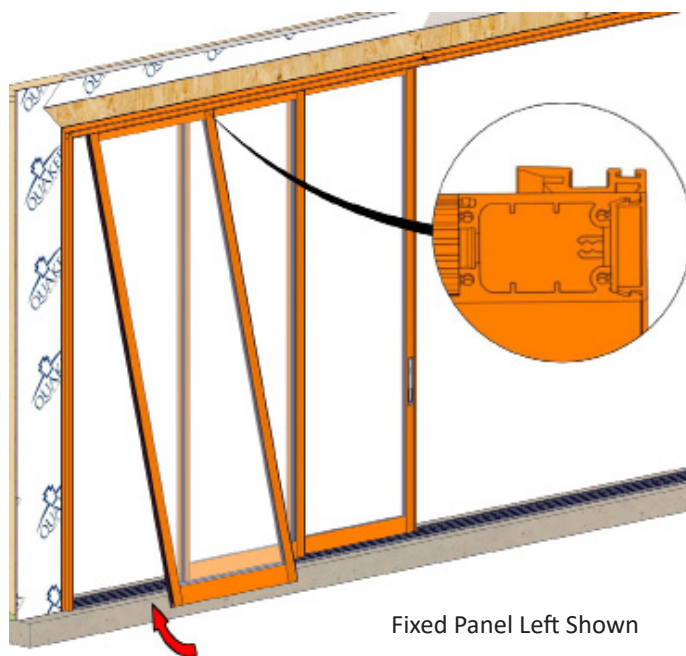

Fixed Panel Left Shown

Repeat for exterior (fixed) panel, setting it into the exterior tracks in the head and sill. Make sure the panels are overlapped when installing so the interlocks will engage properly.

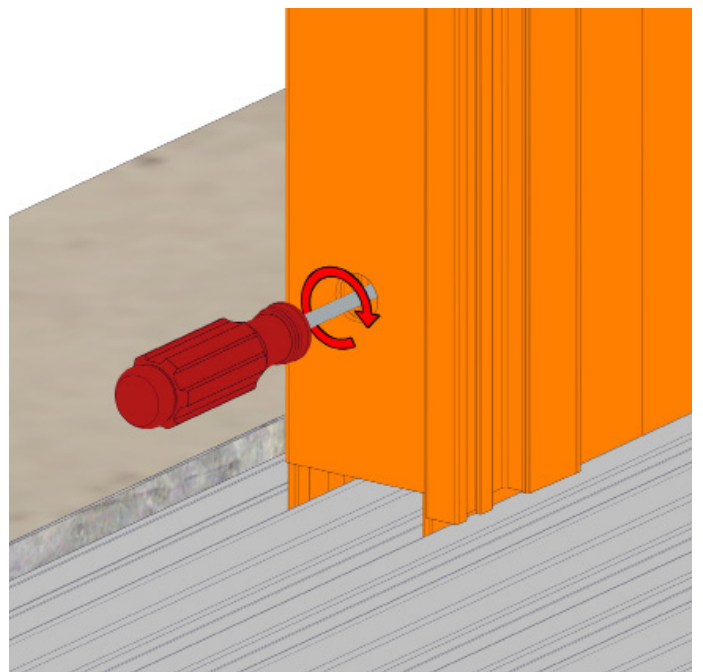

Use a #2 phillips screwdriver to engage the roller adjustment on both sides of a panel. Turn clockwise to raise the panel and provide smooth rolling. If possible, lift the panels slightly when adjusting to take pressure off the rollers. Roll panel back and forth 2-3 times to verify roller height is set. Repeat this step for each panel installed.

40

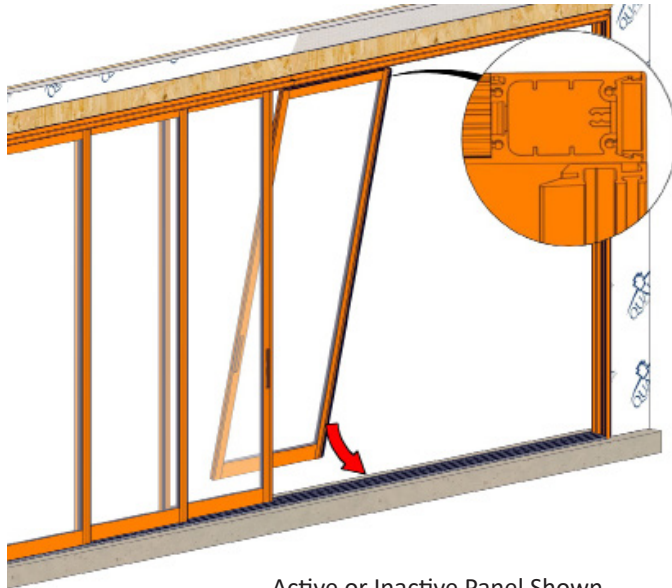

Active or Inactive Panel Shown

Next install the most interior panel on the right side as before, placing in the most inside tracks.

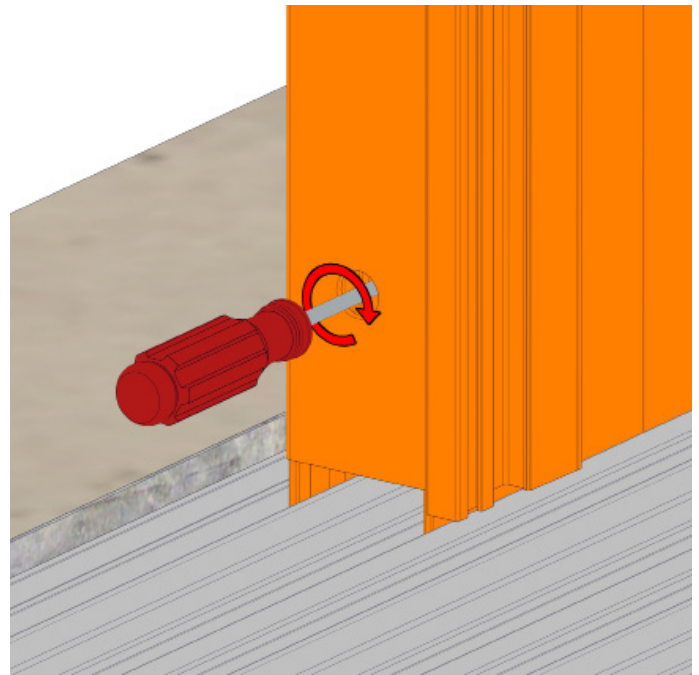

Use a #2 phillips screwdriver to engage the roller adjustment on both sides of a panel. Turn clockwise to raise the panel and provide smooth rolling. If possible, lift the panels slightly when adjusting to take pressure off the rollers. Roll panel back and forth 2-3 times to verify roller height is set. Repeat this step for each panel installed.

41

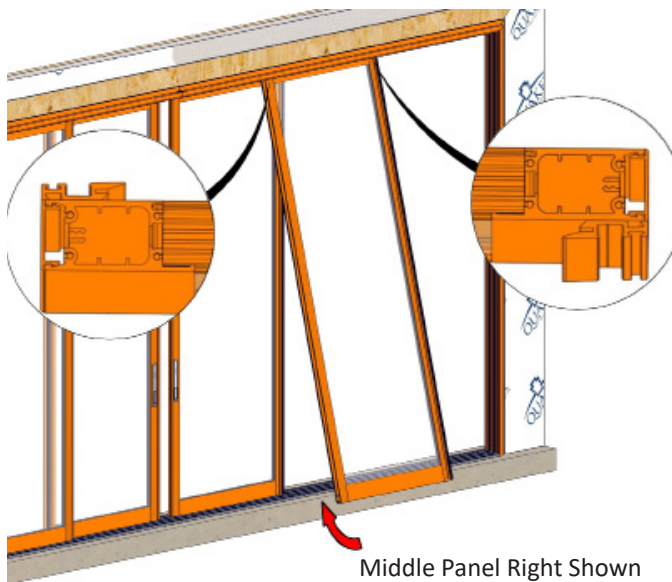

Middle Panel Right Shown

Repeat for the middle panel on the right placing it in the center tracks. Make sure the panel overlaps the center panel on the right so the interlocks will engage properly.

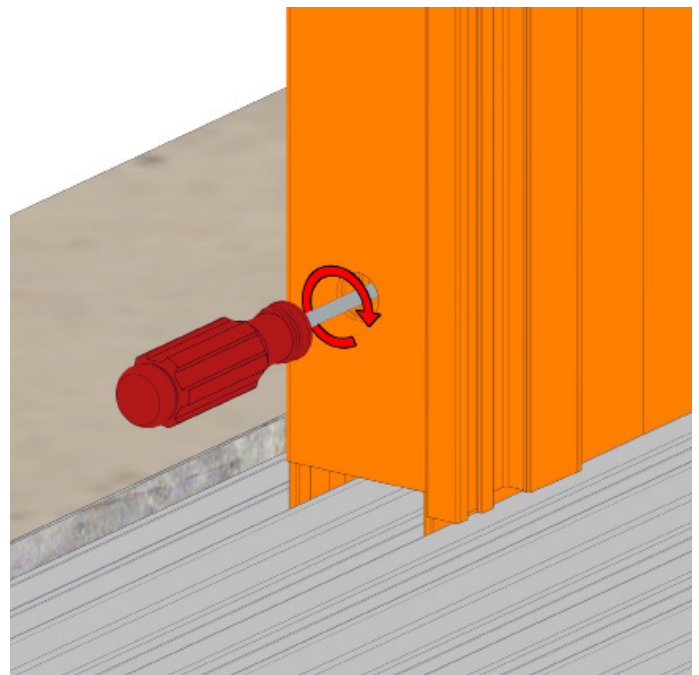

Use a #2 phillips screwdriver to engage the roller adjustment on both sides of a panel. Turn clockwise to raise the panel and provide smooth rolling. If possible, lift the panels slightly when adjusting to take pressure off the rollers. Roll panel back and forth 2-3 times to verify roller height is set. Repeat this step for each panel installed.

42

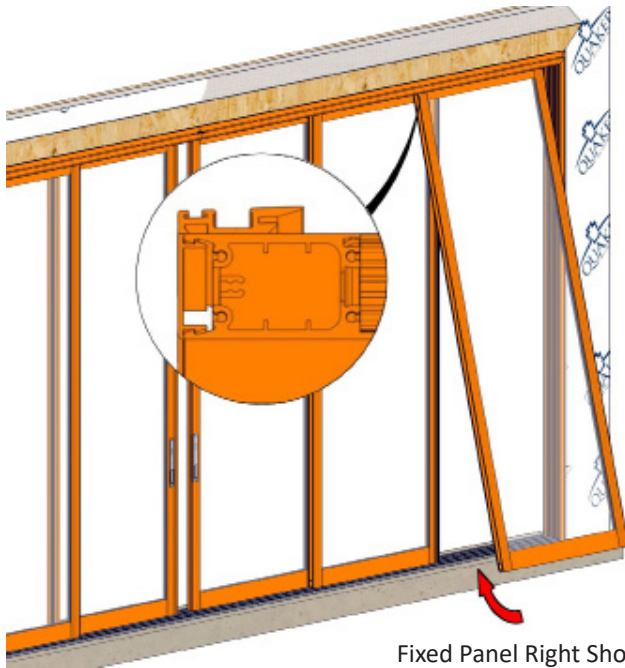

Fixed Panel Right Shown

Repeat for the right exterior panel, setting it in the exterior tracks.

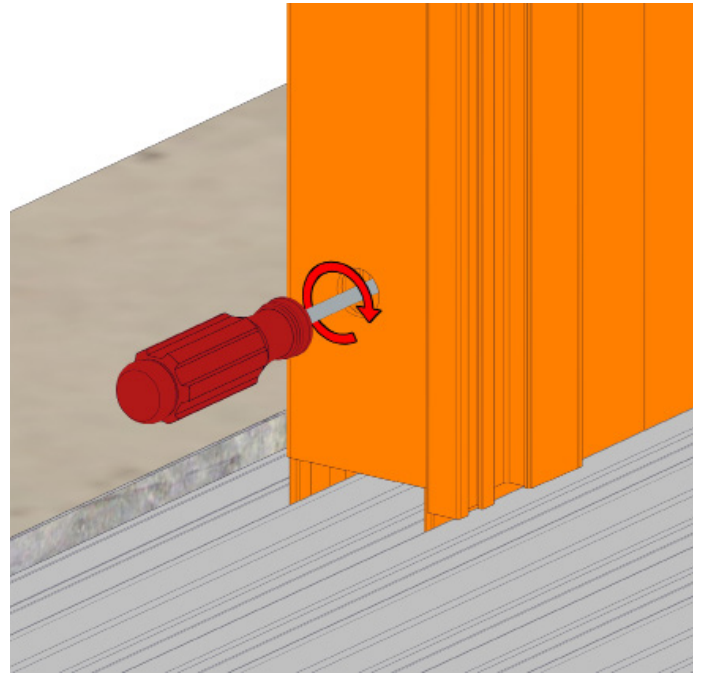

Use a #2 phillips screwdriver to engage the roller adjustment on both sides of a panel. Turn clockwise to raise the panel and provide smooth rolling. If possible, lift the panels slightly when adjusting to take pressure off the rollers. Roll panel back and forth 2-3 times to verify roller height is set. Repeat this step for each panel installed.

43

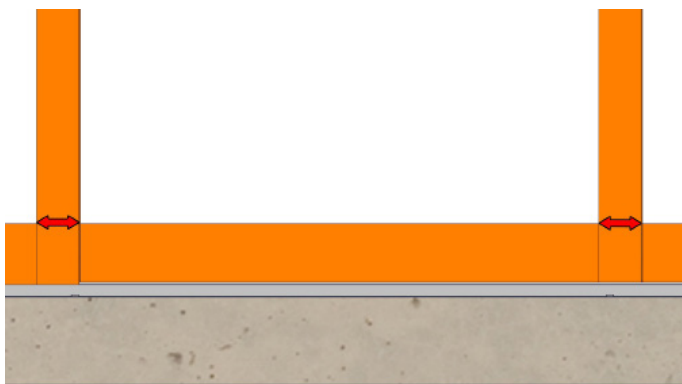

Lock the active panel, and adjust rollers on all panels so they roll smoothly. Start with the active panel and work your way towards the fixed panel. Check the reveal of the glass at the bottom of panels and adjust as needed to line up all panels.

44

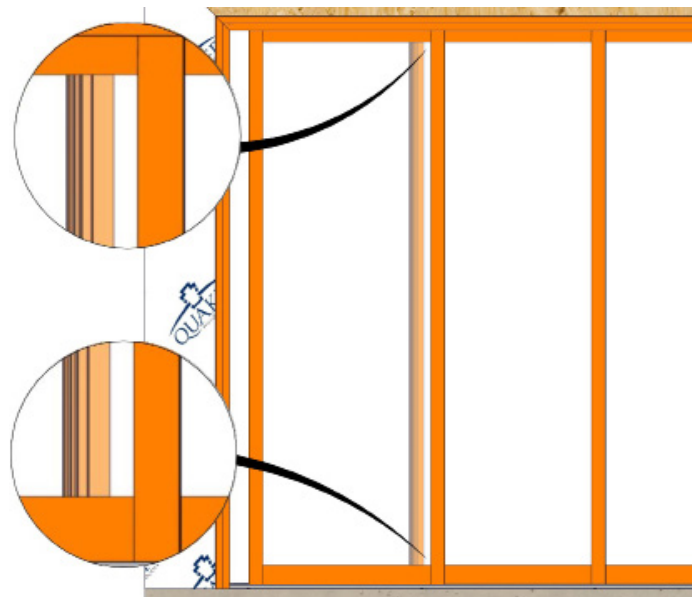

Slide each set of panels apart to check that the reveal matches at the top and bottom. Adjust rollers as needed to match reveal across panels.

45

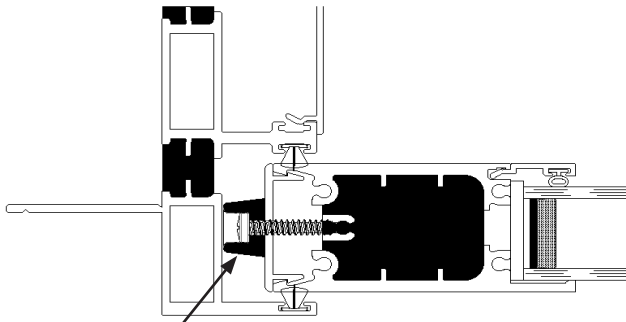

3/8" Panel Spacer

Set the fixed panel 2.5" from the edge of the frame to the edge of the glass of the fixed panel. Be sure the 3/8" panel bumper is installed onto the vinyl prior to sliding jamb into wall.

46

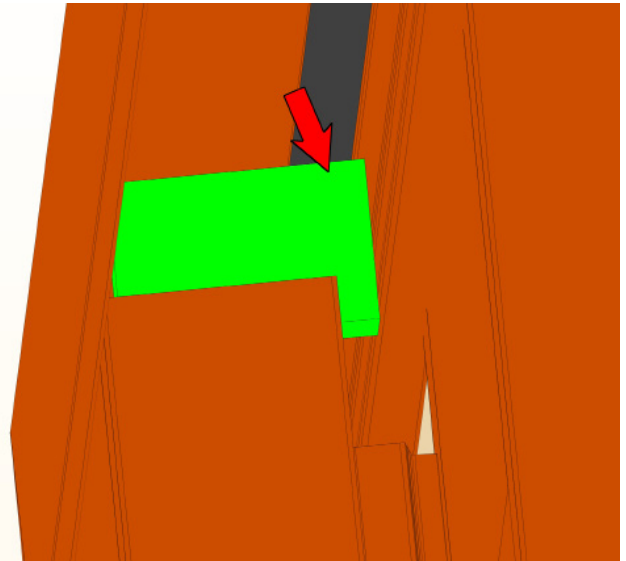

Slide the fix panel fully into the frame jamb, then take the frame head dust plug and remove backing. Slide the dust plug in between the head and the top of the fixed panel. The edge of the panel and the face of the dust plug should be flush. Each panel should get a dust plug.

47

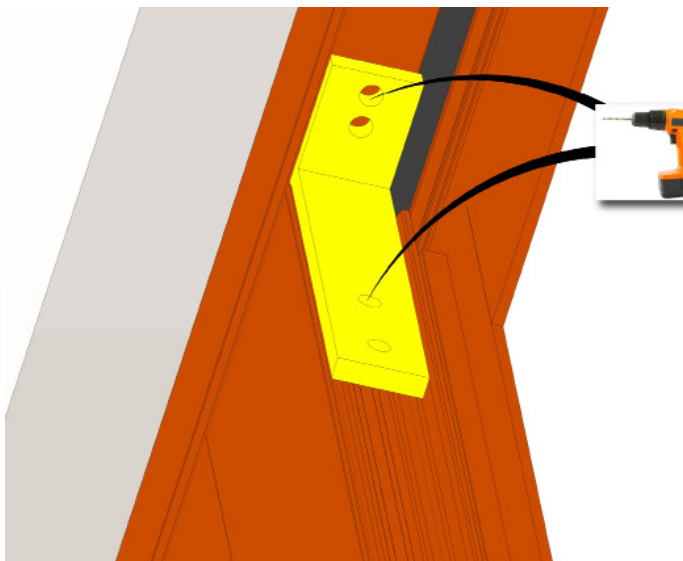

Take the **Fixed Panel Bracket**, slide it to the head drill holes for the tri-wing screws.

48

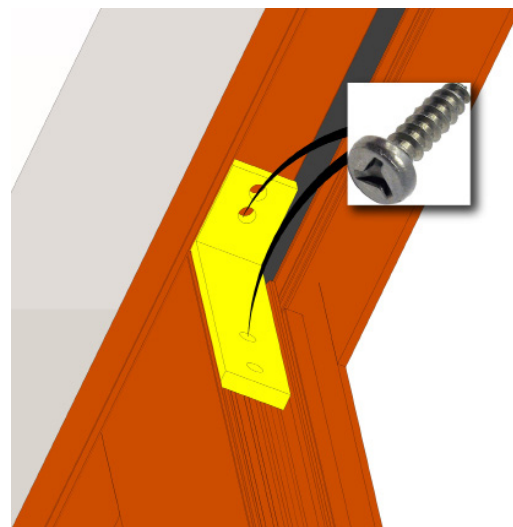

Install the tri-wing screws.

49

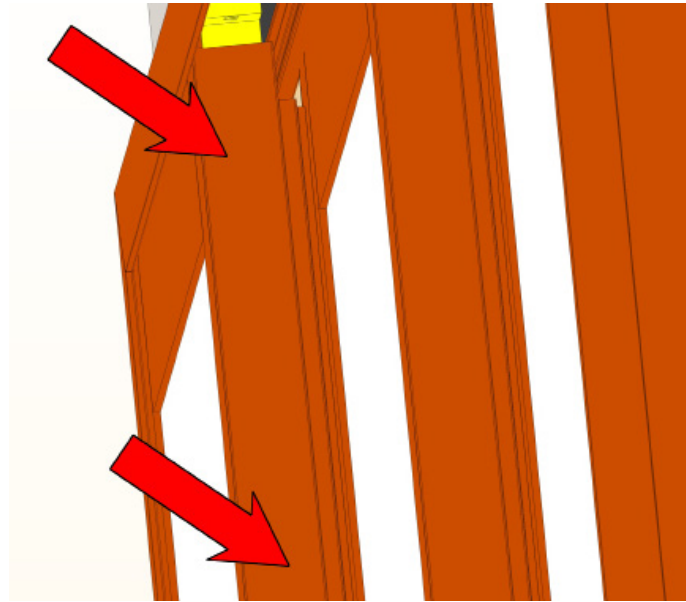

Install the panel cap on the fixed panel frame to cover the fixed panel bracket.
Make flush with the head.

50

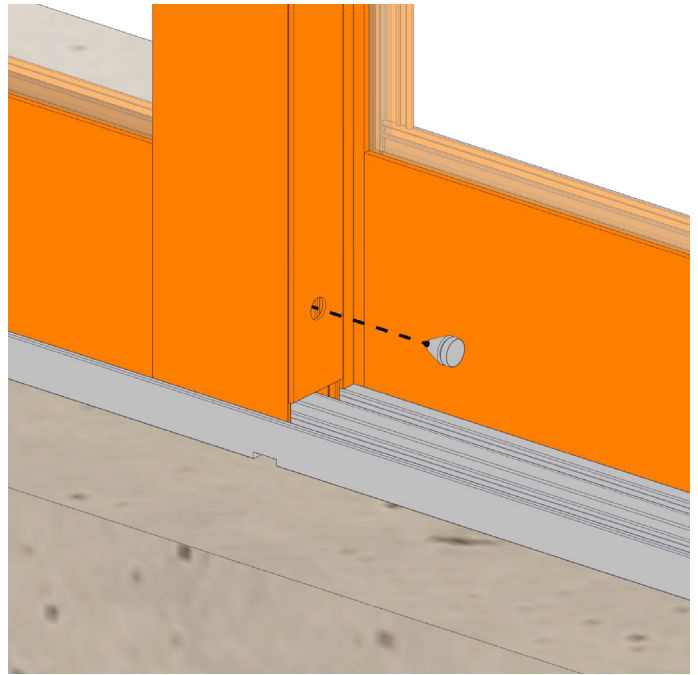

Once all panels have been adjusted install the panel bumpers into each roller adjustment hole interior and exterior.

51

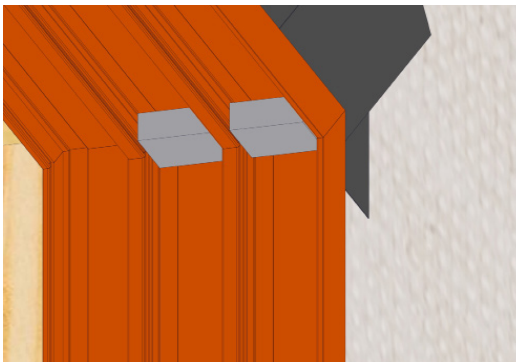

Place 1 dust plug in each track where the heads meet, as shown in the picture above, except the locking panels.

Frame Covers

52

Exterior

Interior

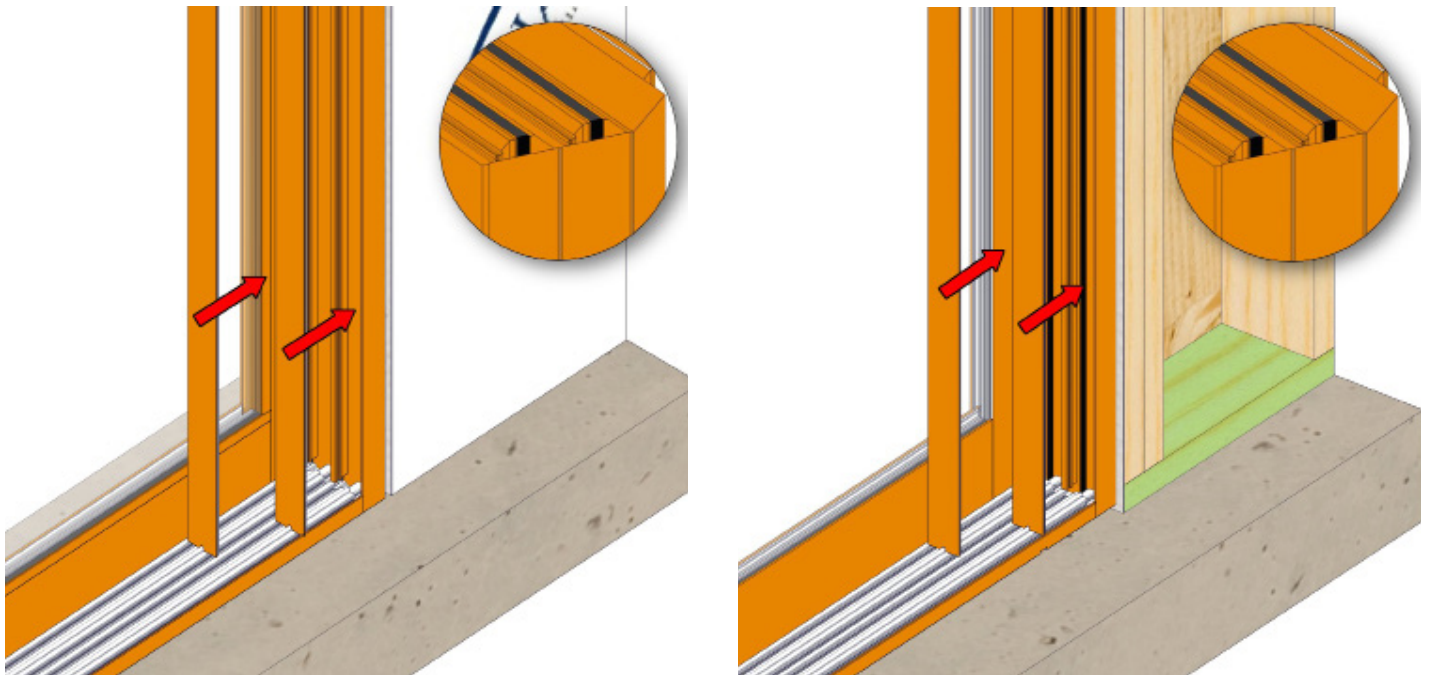

On the exterior jambs of the door, install two frame jamb covers - one in the middle track and one in the outermost track. Repeat for the interior jambs for the middle and most interior jambs. If a mallet is needed to install the jamb covers, use a wood block in between. **DO NOT HIT THE JAMB COVERS DIRECTLY!**

53

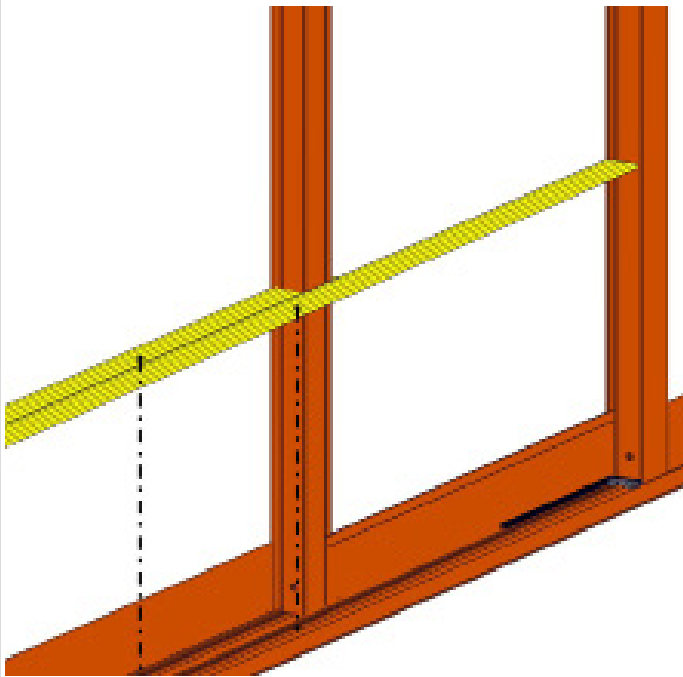

Lay out sill cover before installing, start with the sill cover closer to the interior.

54

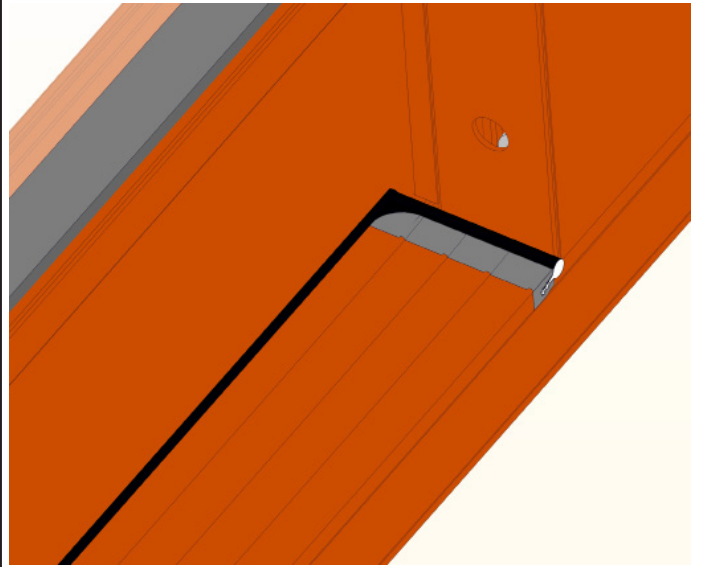

Take the sill covers and cut the end of the cover that doesn't have the molded part on the end.
(Molded part is shown in the picture above.)

55

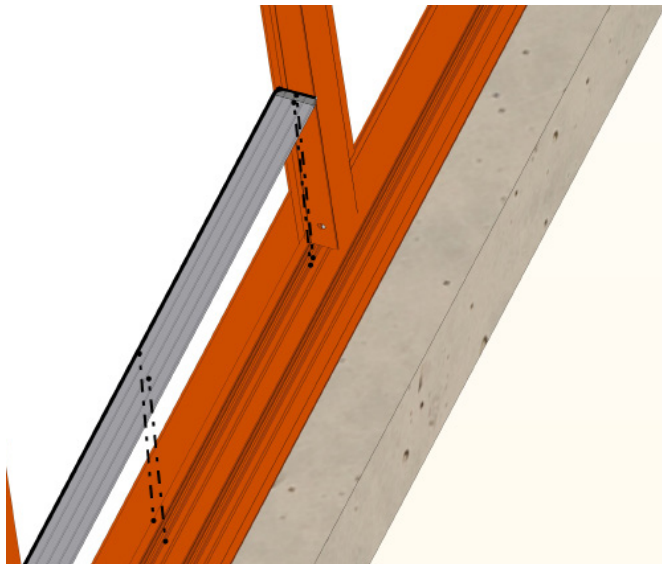

Install the interior sill cover.
DO NOT HIT THE HEADER COVERS DIRECTLY DURING INSTALL!
NOTE: ON ACTIVE PANEL MEASURE FROM PANEL TO FRAME AND SUBTRACT 1/16", CUT, THEN PLACE AGAINST FRAME.

56

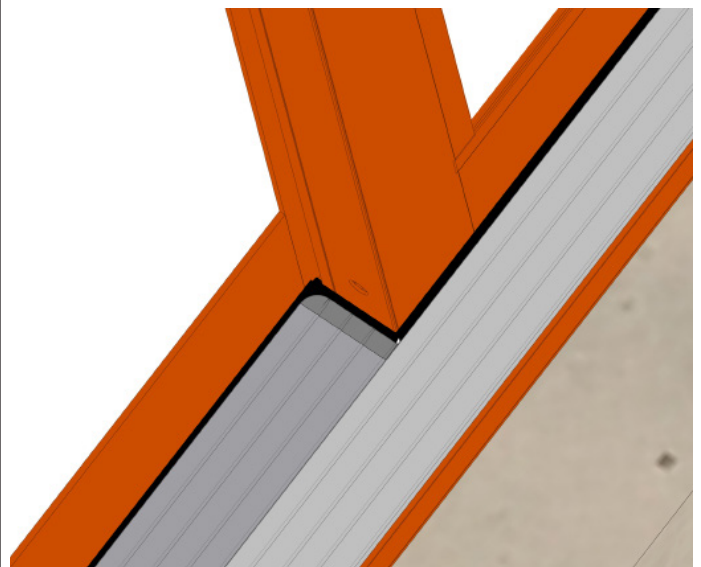

On the exterior sill cover cut away the weather strip where it meets the sill cap you just previously installed.

57

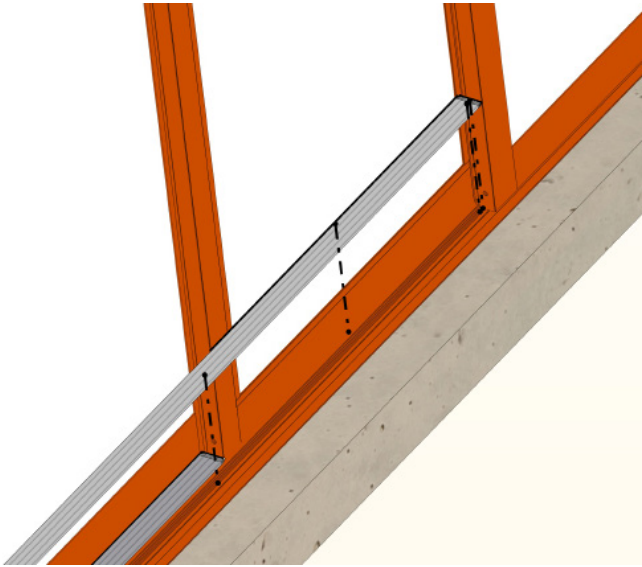

Next install the exterior sill cover.
DO NOT HIT THE SILL COVERS DIRECTLY DURING INSTALL!
NOTE: ON ACTIVE PANEL MEASURE FROM PANEL TO FRAME AND SUBTRACT 1/16", CUT, THEN PLACE AGAINST FRAME.

58



Next install the short and long header covers in the exterior and middle tracks. Trim covers to fit if needed.
DO NOT HIT THE HEADER COVERS DIRECTLY DURING INSTALL!
NOTE: ON ACTIVE PANEL MEASURE FROM PANEL TO FRAME AND SUBTRACT 1/16", CUT, THEN PLACE AGAINST FRAME.

Weather Proofing

59



Apply flashing tape at the sides of the door as shown. Smooth using a J-roller. Extend tape a minimum of 2" past door frame, but not more than the thickness of the flashing tape.

60

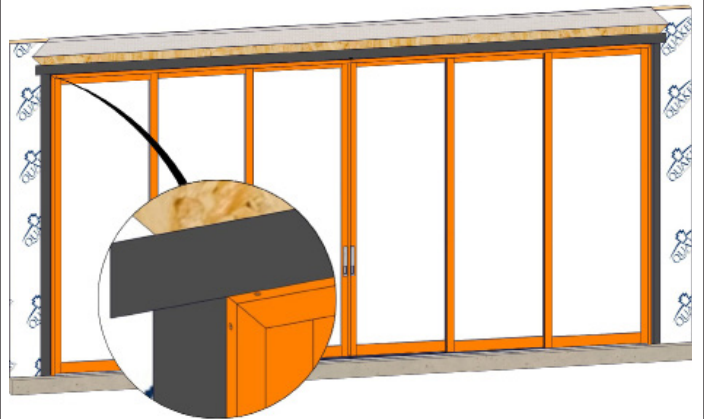

Apply a 3/8" sealant bead to the top exterior edge of door frame before installing the drip cap. Apply flashing tape over the drip cap leg, overlapping the side flashing as shown. Smooth using a J-roller.



Side flashing cannot extend above the top flashing. Doing so could result in product or property damage.

61



Unfold the house wrap top flap and tape the angled seams as shown.

62

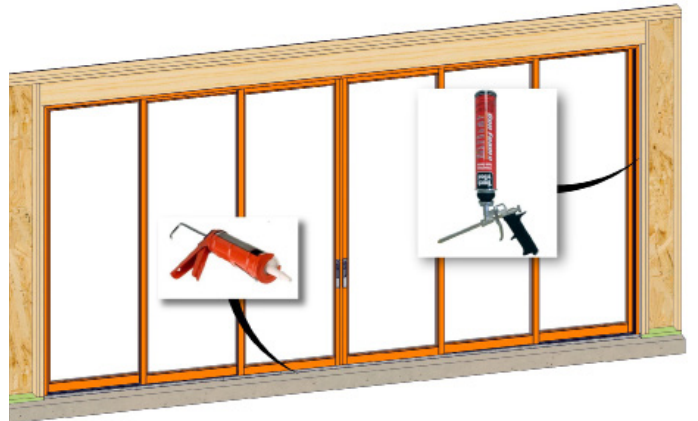

Insulate the gap between the door and framing with minimally expanding spray foam, and seal the entire interior perimeter with sealant.

63

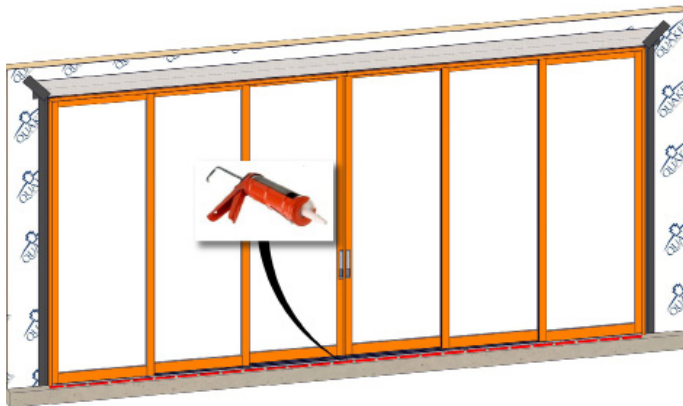

Apply a continuous bead of sealant at the exterior base of the sill. Be sure to not block the weeps on the bottom of the sill.

64

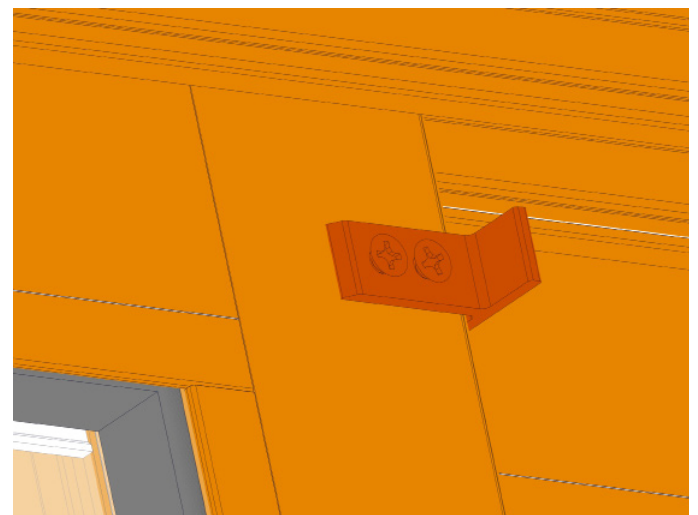

On the interior side of the center panels, take the panel pickups (Part #: M25296-PCS) and #10 screw (Part #:MF10AX1) that is provided. Take screws and attach the pickups. Install the panel pickup where the holes are already fab'd on the interior side of the door.